



## Boxo käsityökalut ja kalusteet



**Sisällysluettelo**

	Sivu
Huoltotyökalut.....	60-61
Hylsyavaimet ja tarvikkeet 1/4".....	32-34
Hylsyavaimet ja tarvikkeet 3/8".....	35-37
Hylsyavaimet ja tarvikkeet 1/2".....	38-41
Hylsyavaimet ja tarvikkeet 3/4".....	42
Hylsyavainsarjat .....	22-24
Jakoavaimet .....	30
Kiintolenkkiavaimet.....	26
Koloavaimet.....	52
Konehylsyavaimet ja tarvikkeet 3/8" .....	44
Konehylsyavaimet ja tarvikkeet 1/2" .....	45-46
Konehylsyavaimet ja tarvikkeet 3/4" .....	47
Konehylsyavaimet ja tarvikkeet 1" .....	48
Lieriötuurnat.....	58
Nivelhylsyavaimet.....	30
Peltisakset .....	56
Pihdit.....	53-56
Pistepuikko .....	58
Rautasaha ja viilat .....	59
Ruuvitaltat.....	50-51
Räikkälänkkiavaimet.....	27-29
Työkalusarjat .....	10-21
Työkaluvaunut ja kalusteet .....	3-9
Vasarat ja tuurnat .....	58



## Työkaluvaunut ja kalusteet





Kaikissa Boxo työkaluvaunuissa tukeva kaksoispeltirakenne sekä 50x125 mm pyörät.

### Työkaluvaunu 7071

Seitsemän kuulalaakeroitua vetolaatikkoa keskuslukituksella, laatikot pysyvät kiinni kahvassa olevan lukitussalvan avulla. Vaunun päällä luistamaton kumimatto. Vaunun päädyissä reikälevyseinä jossa yleisimmin käytetty 9x38 mm reikäjako.

#### Vaunun mitat:

- Leveys 680 mm
- Syvyys 460 mm
- Korkeus 1000 mm
- Paino 70 kg

#### Laatikoiden mitat:

- 5 kpl 569x397x75 mm
- 2 kpl 569x397x154 mm

Yhteen laatikkoon mahtuu kolme Boxo-työkalumodulia.

**Tuotekoodi 285-7071**



6 416240 569148

### 7071 vaunu ja 189-osainen työkaluvalikoima

#### Sisältää sarjat:

- 284-BX037
- 284-BX002A
- 284-BX003A
- 284-BX005
- 284-BX006
- 284-BX009
- 284-BX013
- 284-BX016
- 284-BX017A
- 284-BX020
- 284-BX021
- 284-BX025



6 416240 569568

**Tuotekoodi 285-7071-12**



### Työkaluvaunu 7048101-7

Seitsemän kuulalaakeroitua vetolaatikkoa keskuslukituksella, laatikot pysyvät kiinni kahvassa olevan lukitussalvan avulla. Lukitussalpa jättää koko laatikon sisäsyvyyden vapaaksi. Vaunun molemmissa päädyissä ylösnostettavat pöytätasot sekä rakenteeseen upotetut kädensijat. Pyöreä muotoilu vähentää mahdollisen törmäyksen aiheuttamia vaurioita. Vaunun päällä luistamaton kumimatto.

#### Vaunun mitat:

- Leveys 794 mm
- Syvyys 480 mm
- Korkeus 1016 mm
- Paino 70 kg

#### Laatikoiden mitat:

- 5 kpl 569x397x75 mm
- 2 kpl 569x397x154 mm

Yhteen laatikkoon mahtuu kolme Boxo-työkalumodulia.

**Tuotekoodi 285-7048101-7**



6 416240 731880

### 7048101-7 vaunu ja 189-osainen työkaluvalikoima

#### Sisältää sarjat:

- 284-BX037
- 284-BX002A
- 284-BX003A
- 284-BX005
- 284-BX006
- 284-BX009
- 284-BX013
- 284-BX016
- 284-BX017A
- 284-BX020
- 284-BX021
- 284-BX025

**Tuotekoodi 285-7048101-7-T12**



6 416240 731903



### 7048101-7 vaunu ja 151-osainen tuumamittainen työkaluvalikoima

#### Sisältää sarjat:

- 284-BX001S
- 284-BX002S
- 284-BX003S
- 284-BX005A
- 284-BX006S
- 284-BX009
- 284-BX013
- 284-BX020S
- 284-BX021

**Tuotekoodi 285-7048101-7-T9**



6 416240 731910



### Työkaluvaunu 7048101-5

Viisi kuulalaakeroitua vetolaatikkoo keskuslukituksella, laatikot pysyvät kiinni kahvassa olevan lukitussalvan avulla. Lukitussalpa jättää koko laatikon sisäsyvyyden vapaaksi. Alin laatikko 312 mm korkea esim. kemikaalien säilytystä varten. Vaunun molemmissa päädissä ylösnostettavat pöytätasot sekä rakenteeseen upotetut kädensijat. Pyöreä muotoilu vähentää mahdollisen törmäyksen aiheuttamia vaurioita. Vaunun päällä luistamaton kumimatto.

#### Vaunun mitat:

- Leveys 794 mm
- Syvyys 480 mm
- Korkeus 1016 mm
- Paino 67 kg

#### Laatikoiden mitat:

- 3 kpl 569x397x75 mm
- 1 kpl 569x397x154 mm
- 1 kpl 569x397x312 mm

Yhteen laatikkoon mahtuu kolme Boxo-työkalumodulia.

**Tuotekoodi 285-7048101-5**



6 416240 731873



### Työkaluvaunu 11648101-12

Kaksitoista kuulalaakeroitua vetolaatikkoo keskuslukituksella, laatikot pysyvät kiinni kahvassa olevan lukitussalvan avulla. Lukitussalpa jättää koko laatikon sisäsyvyyden vapaaksi. Vaunun molemmissa päädissä ylösnostettavat pöytätasot sekä rakenteeseen upotetut kädensijat. Pyöreä muotoilu vähentää mahdollisen törmäyksen aiheuttamia vaurioita. Vaunun päällä puukuitutyötaaso.

#### Vaunun mitat:

- Leveys 1162 mm
- Syvyys 480 mm
- Korkeus 1016 mm
- Paino 127 kg

#### Laatikoiden mitat:

- 1 kpl 935x397x120 mm
- 5 kpl 569x397x75 mm
- 1 kpl 569x397x154 mm
- 4 kpl 308x397x75 mm
- 1 kpl 308x397x233 mm

569 mm leveisiin laatikoihin mahtuu kolme Boxo-työkalumodulia kuhunkin.

**Tuotekoodi 285-11648101-12**



6 416240 731897



### Työkalulaatikosto 70661

Soveltuu käytettäväksi 7071 työkaluvaunun ylälaatikostona. Kuusi kuulalaakeroitua vetolaatikkoa keskuslukituksella, kannessa kaasujouset.

#### Laatikoston mitat:

- Leveys 660 mm
- Syvyys 406 mm
- Korkeus 489 mm
- Paino 39 kg

#### Laatikoiden mitat:

- 5 kpl 559x368x49 mm
- 1 kpl 559x368x74 mm

HUOM: Boxo työkalumodulit eivät mahdu 70661 laatikostoon.

Tuotekoodi 285-70661



6 416240 569919



### Työkalulaatikosto 704855-8

Soveltuu käytettäväksi 7048101 vaunujen ylälaatikostona. Kahdeksan kuulalaakeroitua vetolaatikkoa keskuslukituksella, kannessa kaasujouset. Laatikoston molemmissa päädyissä rakenteeseen upotetut kädensijat.

#### Laatikoston mitat:

- Leveys 794 mm
- Syvyys 480 mm
- Korkeus 546 mm
- Paino 49 kg

#### Laatikoiden mitat:

- 4 kpl 569x397x50 mm
- 1 kpl 569x397x75 mm
- 3 kpl 168x397x50 mm

569 mm leveisiin laatikoihin mahtuu kolme Boxo-työkalumodulia kuhunkin – huomioi kuitenkin laatikoiden korkeus, korkeammat modulit eivät mahdu 50 mm korkeisiin laatikoihin.

Tuotekoodi 285-704855-8



6 416240 731859



### Työkalulaatikosto 704855-5

Soveltuu käytettäväksi 7048101 vaunujen ylälaatikostona. Viisi kuulalaakeroitua vetolaatikkoa keskuslukituksella, kannessa kaasujouset. Laatikoston molemmissa päädyissä rakenteeseen upotetut kädensijat.

#### Laatikoston mitat:

- Leveys 794 mm
- Syvyys 480 mm
- Korkeus 546 mm
- Paino 46 kg

#### Laatikoiden mitat:

- 2 kpl 569x397x50 mm
- 3 kpl 569x397x75 mm

569 mm leveisiin laatikoihin mahtuu kolme Boxo-työkalumodulia kuhunkin – huomioi kuitenkin laatikoiden korkeus, korkeammat modulit eivät mahdu 50 mm korkeisiin laatikoihin.

Tuotekoodi 285-704855-5



6 416240 731842



### Työkalulaatikosto 1164855-8

Soveltuu käytettäväksi 11648101-12 vaunun ylälaatikostona. Kahdeksan kuulalaakeroitua vetolaatikkoa keskuslukituksella, kannessa kaasujousi. Laatikoston molemmissa päädyissä rakenteeseen upotetut kädensijat.

#### Laatikoston mitat:

- Leveys 1162 mm
- Syvyys 480 mm
- Korkeus 541 mm
- Paino 64 kg

#### Laatikoiden mitat:

- 4 kpl 569x397x75 mm
- 4 kpl 308x397x75 mm

569 mm leveisiin laatikoihin mahtuu kolme Boxo-työkalumodulia kuhunkin.

Tuotekoodi 285-1164855-8



6 416240 731866



### Työpöytä

Tukeva teräsrunkoinen työpöytä, ainevahvuus 2 mm. Täysteräksinen pöytätaaso jonka päällä 12 mm PVC-levy. Säädettävät jalat.

#### Pöydän mitat:

- Leveys 1565 mm
- Syvyys 766 mm
- Korkeus 800 mm + 90 mm säätöjalat
- Paino 52 kg

Tuotekoodi 285-6200



6 416240 568257

### Reikälevy työpöytään

Täysleveä 500 mm korkea (mukana tulevien jalkojen kanssa 670 mm) reikälevy yleisimmin käytetyllä 9x38 mm reikäjaolla. Kiinnitetään ruuviliitoksella pöydän jalkoihin. Paino 19,5 kg.

Tuotekoodi 285-6200-1



6 416240 568264

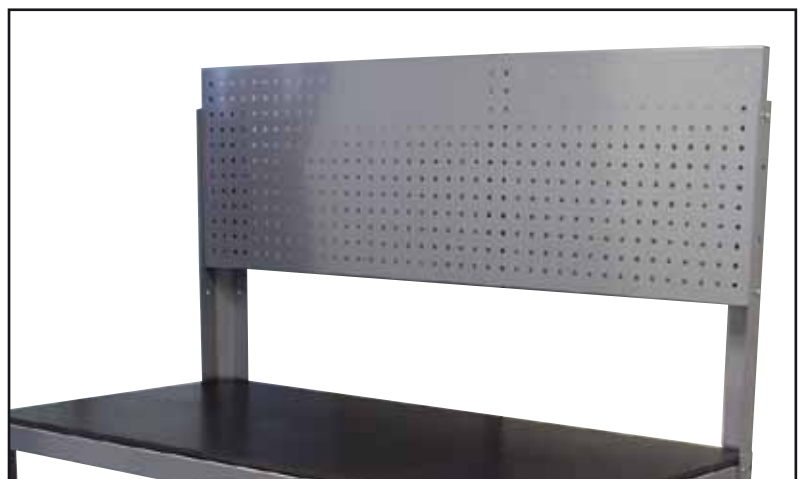



### Työkalukaappi työpöytään

Täysleveä lukittavilla rulo-ovilla varustettu 600 mm korkea kaappi jonka reikälevyissä yleisimmin käytetty 9x38 mm reikäjako. Kiinnitetään ruuviliitoksella pöydän jalkoihin. Paino 35,50 kg.

Tuotekoodi 285-6200-2



6 416240 568271



### Työpöydän alle kiinnitettävä vetolaatikosto

Kolme rullalaakeroitua lukittavaa vetolaatikkoa. Laatikoston päädyissä kantokahvat.

#### Laatikoston mitat:

- Leveys 668 mm
- Syvyys 313 mm
- Korkeus 270 mm
- Paino 15,50 kg

#### Laatikoiden mitat:

- 2 kpl 568x262x50 mm
- 1 kpl 568x262x75 mm

Tuotekoodi 285-26301



6 416240 568288



### Työpöydän alle mahtuva työkaluvaunu

Viisi kuulalaakeroitua vetolaatikkoa keskuslukituksella. Vaunun päällä luistamaton kumimatto.

#### Vaunun mitat:

- Leveys 570 mm
- Syvyys 340 mm
- Korkeus 769 mm
- Paino 31,3 kg

#### Laatikoiden mitat:

- 3 kpl 479x293x75 mm
- 2 kpl 479x293x154 mm

Tuotekoodi 285-22551







6 416240 626827



### Seinälle kiinnitettävät reikälevyt

Levyjen reikäjako yleisimmin käytetty 9x38 mm.  
Jokaisessa levyn taustalla vahvikekaistaleet joissa kiinnitysreiät joista kiinnittämällä levyn kaikki neliöreiät jäävät vapaaseen käyttöön.

Levyn koko	Tuotekoodi	
454x1000 mm	<b>285-RL0500</b>	
950x1000 mm	<b>285-RL1000</b>	
950x1500 mm	<b>285-RL1500</b>	
950x1976 mm	<b>285-RL2000</b>	

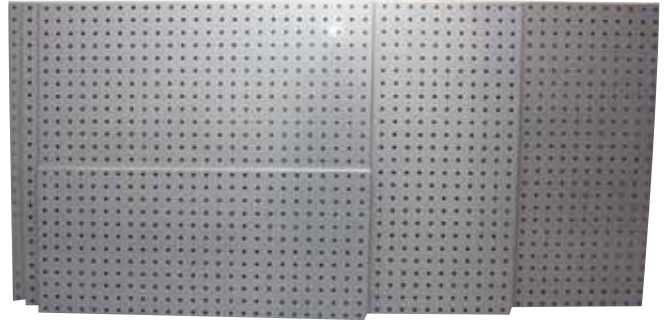

### Huoltovaunut

#### Kolmetasoinen huoltovaunu

Yksittäisen tason kantavuus 60 kg,  
yhteiskantavuus 180 kg.

#### Vaunun mitat:

- Leveys 702 mm
- Syvyys 490 mm
- Korkeus 840 mm
- Paino 19 kg

Tuotekoodi 285-30030



#### Huoltovaunu kannellisella ylälokerolla ja vetolaatikostolla

Lukittava kansi lukitsee myös vetolaatikon.  
Kannessa kaasujouset.  
Yksittäisen vetolaatikon kantavuus 40 kg,  
alatasen ja ylälaatikon kantavuus 60 kg.  
Yhteiskantavuus 200 kg.

#### Vaunun mitat:

- Leveys 780 mm
- Syvyys 495 mm
- Korkeus 908 mm
- Paino 46 kg

Tuotekoodi 285-3321





## Työkalusarjat







6 416240 632316

**Hylsysarja 1/4"**
**Sisältö:**

- 13 kpl hylsyjä (6K): 4 – 4,5 – 5 – 5,5 – 6 – 7 – 8 – 9 – 10 – 11 – 12 – 13 – 14 mm
- 9 kpl pitkiä hylsyjä (6K): 5 – 6 – 7 – 8 – 9 – 10 – 11 – 12 – 13 mm
- 72-hampainen räikkäväännin suunnanvaihto levyllä
- 150 mm ruuvitaltaväännin
- T-väännin
- Nivel
- 3 kpl jatkovarsia: 50 – 100 – 150 mm
- 9-os. kuusiokoloavainsarja: 1,5 – 2 – 2,5 – 3 – 4 – 5 – 6 – 8 – 10 mm
- Bits-hylsyt:
  - Kuusiokolo: 3 – 4 – 5 – 6 – 7 mm
  - Uraruuvi: 4 – 4,5 – 5 – 5,5 – 6 mm
  - PH: 0 – 1 – 2 – 3
  - PZ: 0 – 1 – 2 – 3
  - Torx: 10 – 15 – 20 – 25 – 27 – 30 – 40

**Tuotekoodi 284-BX001**

6 416240 731927

**Hylsysarja 1/4"**
**Sisältö:**

- 13 kpl hylsyjä (6K): 4 – 4,5 – 5 – 5,5 – 6 – 7 – 8 – 9 – 10 – 11 – 12 – 13 – 14 mm
- 13 kpl pitkiä hylsyjä (6K): 4 – 4,5 – 5 – 5,5 – 6 – 7 – 8 – 9 – 10 – 11 – 12 – 13 – 14 mm
- 72-hampainen räikkäväännin suunnanvaihto vivulla
- 150 mm ruuvitaltaväännin
- T-väännin
- Nivel
- 3 kpl jatkovarsia: 50 – 100 – 150 mm
- 9-os. kuusiokoloavainsarja: 1,5 – 2 – 2,5 – 3 – 4 – 5 – 6 – 8 – 10 mm
- Bits-hylsyt:
  - Kuusiokolo: 2,5 – 3 – 4 – 5 – 6 – 7 – 8 mm
  - Uraruuvi: 3 – 4 – 4,5 – 5 – 5,5 – 6 – 8 mm
  - PH: 0 – 1 – 2 – 3 – 4
  - PZ: 0 – 1 – 2 – 3
  - Torx: 8 – 10 – 15 – 20 – 25 – 27 – 30 – 40

**Tuotekoodi 284-BX037**

6 416240 632323

**Hylsysarja 1/4" tuumamitat**
**Sisältö:**

- 12 kpl hylsyjä (6K): 5/32 – 3/16 – 7/32 – 1/4 – 9/32 – 5/16 – 11/32 – 3/8 – 7/16 – 15/32 – 1/2 – 9/16
- 9 kpl pitkiä hylsyjä (6K): 3/16 – 7/32 – 1/4 – 9/32 – 5/16 – 11/32 – 3/8 – 7/16 – 1/2
- 72-hampainen räikkäväännin
- 150 mm ruuvitaltaväännin
- T-väännin
- Nivel
- 3 kpl jatkovarsia: 50 – 100 – 150 mm
- 13-os. kuusiokoloavainsarja: 0.05" – 1/16 – 5/64 – 3/32 – 7/64 – 1/8 – 9/64 – 5/32 – 3/16 – 7/32 – 1/4 – 5/16 – 3/8
- Bits-hylsyt:
  - Kuusiokolo: 3/32 – 1/8 – 5/32 – 7/32
  - Uraruuvi: 1/8 – 9/64 – 5/32 – 3/16
  - PH: 0 – 1 – 2 – 3
  - PZ: 0 – 1 – 2 – 3
  - Torx: 10 – 15 – 20 – 25 – 27 – 30 – 40

**Tuotekoodi 284-BX001S**

### Hylsysarja 3/8"

**Sisältö:**

- 17 kpl hylsyjä (6K): 6 – 8 – 9 – 10 – 11 – 12 – 13 – 14 – 15 – 16 – 17 – 18 – 19 – 20 – 21 – 22 – 24 mm
- 2 kpl sytytystulppahylsyjä (6K): 16 - 21 mm
- 72-hampainen räikkäväännin suunnanvaihto levyllä
- T-väännin
- Nivel
- 3 kpl jatkovarsia: 75 –150 – 250 mm

**Tuotekoodi 284-BX002**



6 416240 632330

### Hylsysarja 3/8"

**Sisältö:**

- 17 kpl hylsyjä (6K): 6 – 8 – 9 – 10 – 11 – 12 – 13 – 14 – 15 – 16 – 17 – 18 – 19 – 20 – 21 – 22 – 24 mm
- 2 kpl sytytystulppahylsyjä (6K): 16 - 21 mm
- 72-hampainen räikkäväännin suunnanvaihto vivulla
- 3 kpl jatkovarsia: 75 –150 – 250 mm
- T-väännin
- Nivel
- Bits-hylsy
- Adapterit 3/8"-1/4" ja 3/8"-1/2"
- Magneettiadapteri

**Tuotekoodi 284-BX002A**



6 416240 716382

### Hylsysarja 3/8" tuumamitat

**Sisältö:**

- 13 kpl hylsyjä (6K): 1/4 – 5/16 – 3/8 – 7/16 – 15/32 – 1/2 – 9/16 – 5/8 – 11/16 – 3/4 – 13/16 – 7/8 – 15/16
- 2 kpl sytytystulppahylsyjä (6K): 5/8 – 13/16 (16 - 21 mm)
- 72-hampainen räikkäväännin
- T-väännin
- Nivel
- 3 kpl jatkovarsia: 75 –150 – 250 mm

**Tuotekoodi 284-BX002S**



6 416240 632347



### Hylsysarja 1/2"

#### Sisältö:

- 19 kpl hylsyjä (6K):  
8 – 10 – 11 – 12 – 13 – 14 – 15 – 16 – 17 – 19 –  
21 – 22 – 23 – 24 – 26 – 27 – 28 – 30 – 32 mm
- 72-hampainen räikkäväännin suunnanvaihto levyllä
- T-väännin
- Nivel
- 2 kpl jatkovarsia: 125 – 250 mm

**Tuotekoodi 284-BX003**



### Hylsysarja 1/2"

#### Sisältö:

- 19 kpl hylsyjä (6K):  
8 – 10 – 11 – 12 – 13 – 14 – 15 – 16 – 17 – 19 –  
21 – 22 – 23 – 24 – 26 – 27 – 28 – 30 – 32 mm
- 72-hampainen räikkäväännin suunnanvaihto vivulla
- T-väännin
- Nivel
- 2 kpl jatkovarsia: 125 – 250 mm
- Bits-hylsy
- Adapteri 1/2"-3/8"
- Magneettiadapteri

**Tuotekoodi 284-BX003A**



### Hylsysarja 1/2" tuumamitat

#### Sisältö:

- 16 kpl hylsyjä (6K):  
5/16 – 3/8 – 7/16 – 15/32 – 1/2 – 9/16 – 5/8 –  
11/16 – 3/4 – 13/16 – 7/8 – 15/16 – 1 – 1 & 1/16 –  
1 & 3/16 – 1 & 1/4
- 72-hampainen räikkäväännin
- T-väännin
- Nivel
- 2 kpl jatkovarsia: 125 – 250 mm

**Tuotekoodi 284-BX003S**



### Lyöntiruuvitalttasarja

#### Sisältö:

- Uraruuvitaltat: 6x38 – 3x75 – 5x100 – 6x100 mm
- Phillips: PH2x38 – PH0x75 – PH1x100 – PH2x100 mm

**Tuotekoodi 284-BX004**



**Ruuvalttasarja**

**Sisältö:**

- Uraruuvitaltat: 6x38 – 3x75 – 5x100 – 6x100 mm
- Phillips: PH2x38 – PH0x75 – PH1x100 – PH2x100 mm

**Tuotekoodi 284-BX004A**



**Lyöntiruuvitalttasarja**

**Sisältö:**

- Uraruuvitaltat: 5x100 – 6x100 – 8x150 – 9,5x200 mm
- Phillips: PH1x100 – PH2x100 – PH3x150 mm

**Tuotekoodi 284-BX005**



**Ruuvalttasarja**

**Sisältö:**

- Uraruuvitaltat: 5x100 – 6x100 – 8x150 – 9,5x200 mm
- Phillips: PH1x100 – PH2x100 – PH3x150 mm

**Tuotekoodi 284-BX005A**

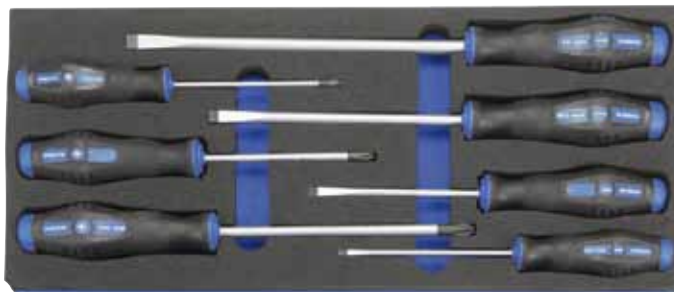

**Torx-lyöntiruuvitalttasarja**

**Sisältö:**

- T20 – 25 – 27 – 30 – 40 – 45 - 50

**Tuotekoodi 284-BX005T**

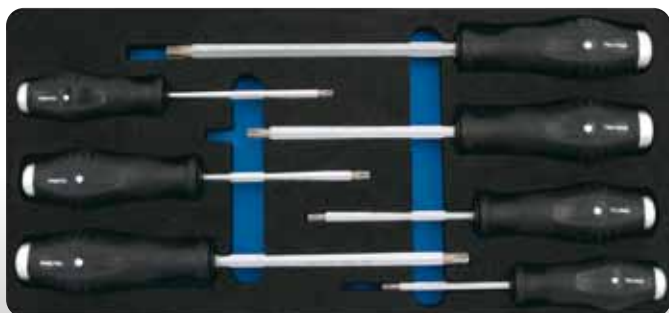



**Torx-ruuvitalttasarja**

**Sisältö:**

- T20 – 25 – 27 – 30 – 40 – 45 - 50

**Tuotekoodi 284-BX005TA**



6 416240 632422



**Kiintolenkkiavainsarja**

**Sisältö:**

- 6 – 7 – 8 – 9 – 10 – 11 – 12 – 13 – 14 – 15 –  
16 – 17 – 18 – 19 – 22 – 24 mm

**Tuotekoodi 284-BX006**



6 416240 632439



**Kiintolenkkiavainsarja tuumamitat**

**Sisältö:**

- 1/4 – 5/16 – 11/32 – 3/8 – 7/16 – 1/2 – 9/16 – 5/8 –  
11/16 – 3/4 – 13/16 – 7/8 – 15/16

**Tuotekoodi 284-BX006S**



6 416240 632446



**Pihtisarja**

**Sisältö:**

- Sivuleikkurit 160 mm  
- Linjapihdit 180 mm  
- Kärkipihdit 200 mm  
- Yleispihdit 250 mm

**Tuotekoodi 284-BX009**



6 416240 632453

### Lukkopihtisarja

**Sisältö:**

- Lukkopihtit kaarevilla leuoilla ja leikkurilla 250 mm
- Pitkäleukaiiset lukkopihtit 150 mm
- Pitkäleukaiiset lukkopihtit 225 mm

**Tuotekoodi 284-BX010**

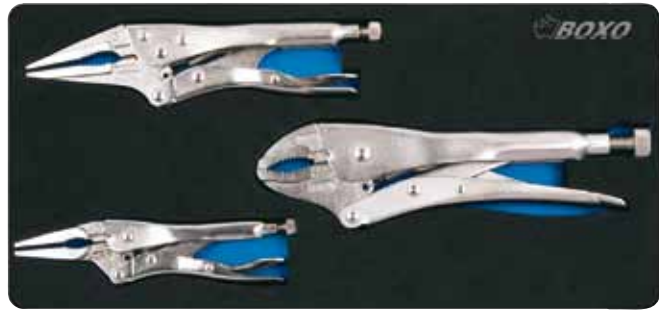

### Tarkkuusruuvitalttisarja

**Sisältö:**

- Ruuvitaltat PH00-PH0-PH1 ja 1,5-2-3 mm
- Elektroniikkapihtit
  - Linjapihtit 125 mm
  - Sivuleikkurit 115 mm
  - Kärkipihtit 125 mm
  - Kärkipihtit taivutetut 125 mm

**Tuotekoodi 284-BX012**

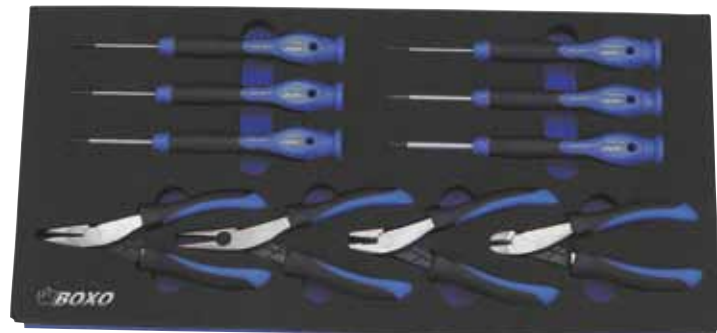

### Vasara/tuurnasarja

**Sisältö:**

- Harjapäivasara 500 g
- Kumi/nylon yhdistelmävasara
- Sokkatuurnat: 4x150 – 5x165 – 6x180 mm
- Pistepuikko

**Tuotekoodi 284-BX013**



### Kuusiokolo/Torx/XZN hylsysarja

**Sisältö:**

- Kuusiokolo: 5x138 – 6x100 – 7x100 – 8x100 mm
- Torx: T40x138 – T45x100 – T55x100 – T70x100 mm
- XZN: M6x100 – M8x100 – M10x100 – M12x100 mm

**Tuotekoodi 284-BX015**







**Hylsyavainsarja 3/8" pitkät hylsy**

Sisältö:

- 8 – 9 – 10 – 11 – 12 – 13 – 14 – 15 –  
16 – 17 – 19 – 21 – 22 – 24 mm

Tuotekoodi 284-BX016



6 416240 632491



**Hylsyavainsarja 3/8" pitkät hylsy tuumamitat**

Sisältö:

- 1/4 – 5/16 – 3/8 – 7/16 – 1/2 – 9/16 – 5/8 – 11/16 –  
3/4 – 13/16 – 7/8 – 15/16

Tuotekoodi 284-BX016S



6 416240 632507



**Hylsyavainsarja 1/2" pitkät hylsy**

Sisältö:

- 10 – 11 – 12 – 13 – 14 – 15 – 16 – 17 – 18 – 19 –  
20 – 21 – 22 – 24 – 27 – 30 – 32 mm

Tuotekoodi 284-BX017A



6 416240 632514



**Nivelhylsyavaimet**

Sisältö:

- 6x7 – 8x9 – 10x11 – 12x13 – 14x15 – 16x17 – 18x19 mm

Tuotekoodi 284-BX019



6 416240 632521

**Pallopäiset kuusiokoloavaimet L-kahvalla**

Sisältö:

- 2 – 2,5 – 3 – 4 – 5 – 6 – 8 – 10 mm

Tuotekoodi 284-BX020



6 416240 632538

**Pallopäiset kuusiokoloavaimet L-kahvalla tuumamitat**

Sisältö:

- 1/8 – 9/64 – 5/32 – 3/16 – 7/32 – 1/4 – 5/16 – 3/8

Tuotekoodi 284-BX020S



6 416240 632545

**Torxavaimet L-kahvalla**

Sisältö:

- T10 – 15 – 20 – 25 – 27 – 30 – 40 – 45 – 50

Tuotekoodi 284-BX021

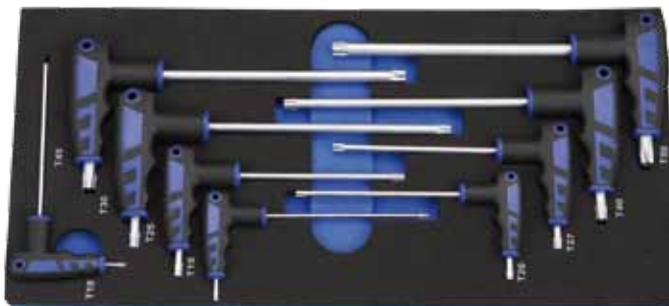

6 416240 632552

**Räikkälenkkiavainsarja nivelellä**

Sisältö:

- 8 – 9 – 10 – 11 – 12 – 13 – 14 – 15 – 16 – 17 – 18 – 19 mm

- Neliöväänninadapterit:

1/4"x10 mm – 3/8"x13 mm – 1/2"x19 mm

Tuotekoodi 284-BX022A



6 416240 632569



6 416240 632576

**Räikkälänkiavainsarja nivelellä tuumamitat**

**Sisältö:**

- 5/16 – 3/8 – 7/16 – 1/2 – 9/16 – 5/8 – 11/16 – 3/4

**Tuotekoodi 284-BX022S**



6 416240 632583

**Räikkälänkiavainsarja suunnanvaihdolla**

**Sisältö:**

- 8 – 9 – 10 – 11 – 12 – 13 – 14 – 15 – 16 – 17 – 18 - 19 mm

**Tuotekoodi 284-BX023**



6 416240 632590

**Räikkälänkiavainsarja suunnanvaihdolla tuumamitat**

**Sisältö:**

- 5/16 – 3/8 – 7/16 – 1/2 – 9/16 – 5/8 – 11/16 – 3/4

**Tuotekoodi 284-BX023S**



6 416240 632606

**Lukkorengaspihntisarja**

**Sisältö:**

- Ulkopuoliset suorat 180 mm
- Ulkopuoliset taivutetut 170 mm
- Sisäpuoliset suorat 180 mm
- Sisäpuoliset taivutetut 170 mm

**Tuotekoodi 284-BX025**



### Viilasarja

**Sisältö:**

- Puolipyöreä viila 200 mm puolikarkea
- Lattaviila 200 mm puolikarkea
- Kolmioviila 200 mm puolikarkea
- Pyöreä viila 200 mm puolikarkea
- Neliöviila 200 mm puolikarkea

**Tuotekoodi 284-BX027**



6 416240 632613

### Pihtisarja pitkät pihdit

**Sisältö:**

- Suorat kärkipihdit
- 45° taivutetut
- 90° taivutetut

**Tuotekoodi 284-BX028**



6 416240 632620

### Konehylsysarja 1/2"

**Sisältö:**

- 15 kpl hylsyjä:
  - 8 – 9 – 10 – 11 – 12 – 13 – 14 – 15 – 16 – 17 – 18 –
  - 19 – 21 – 22 – 24 mm
- 5 kpl pitkiä hylsyjä: 17 – 19 – 21 – 22 – 24 mm
- 3 kpl erikoisohuita suojattuja pitkiä hylsyjä: 17 – 19 – 21 mm
- Konenivel
- Jatkovarsi 125 mm
- 3/4" -> 1/2" adapteri

**Tuotekoodi 284-BX029**



6 416240 632637

### Torx/kuusiokolokonehylsysarja 1/2"

**Sisältö:**

- 9 kpl Torx-hylsyjä:
  - E10 – E11 – E12 – E14 – E16 – E18 – E20 – E22 – E24
- 10 kpl Torx-hylsykärkiä:
  - T20 – 25 – 27 – 30 – 40 – 45 – 50 – 55 – 60 – 70
- 9 kpl kuusiokolohylsykärkiä:
  - 4 – 5 – 6 – 8 – 10 – 12 – 14 – 17 – 19 mm

**Tuotekoodi 284-BX032**



6 416240 632644



6 416240 632651

**Torx-työkalusarja 1/4" & 1/2"**

**Sisältö:**

- 6 kpl 1/4" Torx-hylsyjä: E4 – E5 – E6 – E7 – E8 – E10
- 8 kpl 1/2" Torx-hylsyjä: E11 – E12 – E14 – E16 – E18 – E20 – E22 – E24
- 12 kpl 1/2" Torx-hylsykärkiä: T10 – 15 – 20 – 25 – 27 – 30 – 40 – 45 – 50 – 55 – 60 – 70
- 4 kpl kaksipäisiä räikkälenkkiavaimia: E6xE8 – E10xE12 – E14xE18 – E20xE24
- 9-osainen pitkä Torx-väänninsarja: T10 – 15 – 20 – 25 – 27 – 30 – 40 – 45 – 50

**Tuotekoodi 284-BX033**



6 416240 632668

**Lukkopihti/peili/magneettinostinsarja**

**Sisältö:**

- Lukkopihdit kaarevilla leuoilla ja leikkurilla 175 & 250 mm
- Joustava 500 mm 1/4" bits-väännin
- Magneettinostin
- Led-valo
- Led-valon pidin
- Peili

**Tuotekoodi 284-BX034**



6 416240 721485

**Lukkopihti/lukkorengaspihtisarja**

**Sisältö:**

- Lukkopihdit kaarevilla leuoilla ja leikkurilla 250 mm
- Ulkopuoliset lukkorengaspihdit 180 mm
- Ulkopuoliset lukkorengaspihdit taivutettu 180 mm
- Sisäpuoliset lukkorengaspihdit 180 mm
- Sisäpuoliset lukkorengaspihdit taivutettu 180 mm
- Monikäyttösakset

**Tuotekoodi 284-BX046**



## Hylsyavainsarjat







## 1/4" hylsyavainsarja 52 osaa

### Sisältö:

- Hylsyt 4-5-6-7-8-9-10-11-12-13 mm
- Pitkät hylsyt 4-5-6-7-8-9-10-12-13 mm
- Bits-hylsyt:
  - Kuusiokolo 3-4-5-6-7-8 mm
  - Uraruuvi 4-5,5-6 mm
  - PH1-PH2-PH3
  - PZ1-PZ2-PZ3
  - XZN M5-6-8
  - Torx T8-10-15-20-25-27-30-40
- Jatkoavarret 50 ja 100 mm
- Ruuvitaltaväännin
- Räikkäväännin
- Nivel
- Magneettiadapteri
- 1/4" bits-hylsy

**Tuotekoodi 284-B33-2052**



6 416240 702125



## 3/8" hylsyavainsarja 36 osaa

### Sisältö:

- Hylsyt 8-9-10-11-12-13-14-15-16-17-18-19-20-21-22 mm
- Pitkät hylsyt 8-9-10-11-12-13-14-15-17-19-21 mm
- Sytytystulppahylsyt 16 ja 21 mm
- Jatkoavarret 150 ja 250 mm
- 250 mm nivelväännin
- Räikkäväännin
- Nivel
- Magneettiadapteri
- Adapteri 3/8"-1/4"

**Tuotekoodi 284-B33-3036**



6 416240 702132



## 1/2" hylsyavainsarja 30 osaa

### Sisältö:

- Hylsyt 10-11-12-13-14-15-16-17-18-19-20-21-22-24-27-30-32 mm
- Pitkät hylsyt 17-19-21 mm
- Sytytystulppahylsyt 16 ja 21 mm
- Jatkoavarret 125 ja 250 mm
- 380 mm nivelväännin
- Räikkäväännin
- Nivel
- Magneettiadapteri
- Adapteri 1/2"-3/8"

**Tuotekoodi 284-B33-1930**



6 416240 702118

### 1/4" ja 1/2" hylsyavainsarja 122 osaa

#### Sisältö:

- 1/4" hylsy 4-4,5-5-5,5-6-7-8-9-10-11-12-13 mm
- 1/4" pitkät hylsy 4-5-6-7-8-9-10-11-12-13 mm
- 1/4" bits-hylsy:
  - Kuusiokolo 3-4-5-6-7-8 mm
  - Uraruuvi 4-5,5-6 mm
  - PH1-PH2-PH3
  - PZ1-PZ2-PZ3
  - XZN M5-6-8
  - Torx T8-10-15-20-25-27-30-40
- 1/4" jatkoavarret 50 ja 100 mm
- 1/4" ruuvitaltaväännin
- 1/4" 115 mm t-väännin
- 1/4" räikkäväännin
- 1/4" nivel
- 1/4" magneettiadapteri
- 1/4" bits-hylsy
- 1/2" hylsy 10-12-13-14-15-16-17-18-19-20-21-22-23-24-27-30-32-34 mm
- 1/2" hylsy 3/8-7/16-1/2-9/16-11/16-3/4"
- 1/2" pitkät hylsy 13-15-17-16 mm
- 1/2" sytytustulpahylsy 16 ja 21 mm
- 1/2" jatkoavarret 125 ja 250 mm
- 1/2" räikkäväännin
- 1/2" nivel
- 1/2" magneettiadapteri
- 1/2" 5/16" bits-hylsy
- Adapteri 1/2"-3/8"
- Kiintolenkkiavaimet 7-8-10-11-12-13-14-15-17-18-19-21-22 mm
- 5/16" bits-kärjet:
  - Kuusiokolo 8-10-12-14 mm
  - Torx T40-45-50-55
  - Uraruuvi 8-10-12 mm
  - PH3-PH4
  - PZ3-PZ4

Tuotekoodi 284-33-B19122



6 416240 702101



### 3/4" hylsyavainsarja 21 osaa

#### Sisältö:

- Hylsy 19-21-22-23-24-26-27-29-30-32-35-36-38-41-46-50 mm
- Jatkoavarret 100, 200 ja 410 mm
- Räikkäväännin
- T-väännin 450 mm

Tuotekoodi 284-33-B3221



6 416240 702149







**Kiintolenkkiavaimet, räikkälenkkiavaimet  
ja jakoavaimet**





## Kiintolenkkiavaimet

Lenkipää 15° kulmassa. Materiaali CrV.  
Mattakromattu, kiillotettu kiintoavainpää.

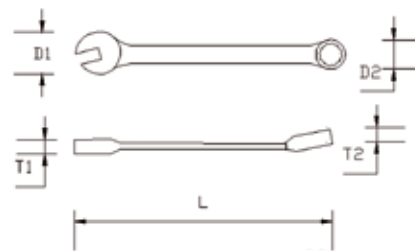

Tuotekoodi	Avainväli	L	D1	D2	T1	T2
284-B35-06	6 mm	105	15,5	10,1	4,2	4,7
284-B35-07	7 mm	115	17	11,5	4,4	5
284-B35-08	8 mm	125	19,2	12,8	4,6	5,5
284-B35-09	9 mm	135	21,2	14,2	4,8	5,9
284-B35-10	10 mm	145	23,2	15,6	5	6,5
284-B35-11	11 mm	155	25,3	16,9	5,4	6,9
284-B35-12	12 mm	165	27,2	18,3	5,5	7,3
284-B35-13	13 mm	175	29,4	19,7	5,9	7,8
284-B35-14	14 mm	185	31,5	21,2	6,2	8,3
284-B35-15	15 mm	195	33,2	22,5	6,4	8,6
284-B35-16	16 mm	205	34,7	24	6,7	8,9
284-B35-17	17 mm	215	36,5	25,3	6,9	9,3
284-B35-18	18 mm	225	38,7	26,8	7,2	9,9
284-B35-19	19 mm	235	40,7	28,1	7,4	10,5
284-B35-20	20 mm	245	43,1	29,7	7,7	10,9
284-B35-21	21 mm	255	44,8	31,3	8	11,3
284-B35-22	22 mm	265	46,9	32,6	8,2	11,5
284-B35-23	23 mm	275	48,3	34,2	8,4	11,8
284-B35-24	24 mm	285	50,4	35,5	8,7	12,1
284-B35-25	25 mm	295	52	36,9	8,9	12,5
284-B35-26	26 mm	305	53,6	38,2	9,2	12,8
284-B35-27	27 mm	315	55,7	39,6	9,4	13,1
284-B35-28	28 mm	325	57,6	40,9	9,7	13,3
284-B35-29	29 mm	335	59,7	42,3	9,9	13,5
284-B35-30	30 mm	345	61,8	43,7	10,1	13,7
284-B35-32	32 mm	365	65,8	46,4	10,4	14,3



Tuotekoodi	Avainväli	L	D1	D2	T1	T2
284-B35-33	33 mm	380	69,2	48,8	10,7	15
284-B35-34	34 mm	380	69,2	48,8	10,7	15
284-B35-36	36 mm	410	74	53	13,5	19,4
284-B35-38	38 mm	430	77	56	15	20,4
284-B35-41	41 mm	460	84	61	16	21,6
284-B35-46	46 mm	500	92	66	17	23
284-B35-50	50 mm	540	73	73	18	24,6
284-B35-55	55 mm	560	86	86	28	21,5
284-B35-60	60 mm	600	94	94	30	23,5
284-B35-65	65 mm	680	108	108	32	25
284-B35-70	70 mm	680	108	108	32	25
284-B35-1/4	1/4"	105	15,5	10,1	4,2	4,7
284-B35-5/16	5/16"	125	19,2	12,8	4,6	5,5
284-B35-11/32	11/32"	135	23,2	15,6	5	6,5
284-B35-3/8	3/8"	145	23,2	15,6	5	6,5
284-B35-7/16	7/16"	155	25,3	16,9	5,4	6,9
284-B35-1/2	1/2"	175	29,4	19,7	5,9	7,8
284-B35-9/16	9/16"	185	31,5	21,2	6,2	8,3
284-B35-5/8	5/8"	205	34,7	24	6,7	8,9
284-B35-11/16	11/16"	215	36,5	25,3	6,9	9,3
284-B35-3/4	3/4"	235	40,7	28,1	7,4	10,5
284-B35-13/16	13/16"	255	44,8	31,3	8	11,3
284-B35-7/8	7/8"	265	46,9	32,6	8,2	11,5
284-B35-15/16	15/16"	285	50,4	35,5	8,7	12,1
284-B35-1	1"	295	52	36,9	8,9	12,5

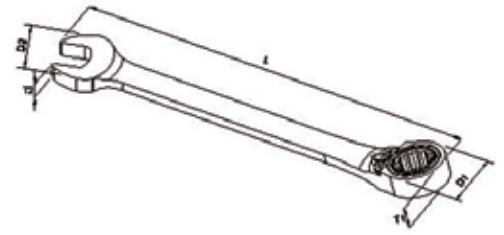

**Räikkälänkiavaimet suunnanvaihdolla**

Tuotekoodi	Avainväli	L	D1	D2	T1	T2
284-B41-08	8 mm	134,4	17,1	16,73	7,4	4,7
284-B41-09	9 mm	158,5	21	21	7,4	5,5
284-B41-10	10 mm	158,5	21	21	7,4	5,5
284-B41-11	11 mm	164,6	22,6	23	8,7	6
284-B41-12	12 mm	167,7	23,8	25	8,7	6,2
284-B41-13	13 mm	177,4	24,9	27,5	8,7	6
284-B41-14	14 mm	189,5	27	29	8,7	7
284-B41-15	15 mm	198,4	28,1	31,5	10,3	7,2
284-B41-16	16 mm	205,4	29,9	33	10,3	7,5
284-B41-17	17 mm	224,4	31,9	34,9	10,3	8
284-B41-18	18 mm	235,4	33,4	36,5	10,6	8,6
284-B41-19	19 mm	246,4	34,4	38,9	10,6	8,8
284-B41-20	20 mm	280	42,6	45,7	13	9,5
284-B41-21	21 mm	280	42,6	45,7	13	9,5
284-B41-22	22 mm	280	42,6	45,7	13	9,5
284-B41-24	24 mm	310	46,5	51,7	13,5	10
284-B41-27	27 mm	330	51	56	15,1	11
284-B41-30	30 mm	425	64	65,5	18	12,5
284-B41-32	32 mm	425	64	65,5	18	12,5



Tuotekoodi	Avainväli	L	D1	D2	T1	T2
284-B41-5/16	5/16"	134,4	17,1	16,73	7,4	4,7
284-B41-3/8	3/8"	158,5	21	21	7,4	5,5
284-B41-7/16	7/16"	164,6	22,6	23	8,7	6
284-B41-1/2	1/2"	177,4	24,9	27,5	8,7	6
284-B41-9/16	9/16"	189,5	27	29	8,7	7
284-B41-5/8	5/8"	205,4	29,9	33	10,3	7,5
284-B41-11/16	11/16"	224,4	31,9	34,9	10,3	8
284-B41-3/4	3/4"	246,4	34,4	38,9	10,6	8,8

**Sarjat pakattuna säilytyspussiin**

8-os. sisältäen koot 8-10-11-12-13-14-17-19 mm

**Tuotekoodi 284-B41-S8**

6 416240 722703



12-os. sisältäen koot 8-9-10-11-12-13-14-15-16-17-18-19 mm

**Tuotekoodi 284-B41-S12**

6 416240 722710



8-os. sisältäen koot 5/16-3/8-7/16-1/2-9/16-5/8-11/16-3/4

**Tuotekoodi 284-B41-S8T**

6 416240 722727

Räikkälänkiavaimet nivelletyllä lenkipäällä

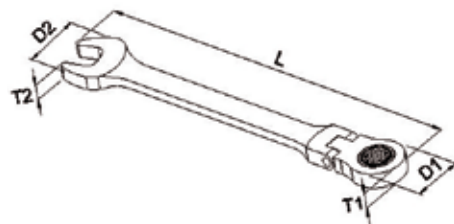

Tuotekoodi	Avainväli	L	D1	D2	T1	T2
284-B42-08	8 mm	136	17,4	16,95	7,4	4,9
284-B42-09	9 mm	158	20,9	20,8	7,4	5,8
284-B42-10	10 mm	158	20,9	20,8	7,4	5,8
284-B42-11	11 mm	175	23,4	25,1	8,7	6,2
284-B42-12	12 mm	175	23,4	25,1	8,7	6,2
284-B42-13	13 mm	185	24,9	27,15	8,7	6,4
284-B42-14	14 mm	193	27,4	29,3	8,7	7,0
284-B42-15	15 mm	213	30,4	33	10,3	7,4
284-B42-16	16 mm	213	30,4	33	10,3	7,4
284-B42-17	17 mm	231	31,9	35,2	10,3	8,2
284-B42-18	18 mm	249	34,5	39,4	10,5	9
284-B42-19	19 mm	249	34,5	39,4	10,5	9



Sarjat pakattuna säilytuspussiin

8-os. sisältäen koot 8-10-11-12-13-14-17-19 mm

Tuotekoodi 284-B42-S8



12-os. sisältäen koot 8-9-10-11-12-13-14-15-16-17-18-19 mm

Tuotekoodi 284-B42-S12



284-B42-5/16	5/16"	136	17,4	16,95	7,4	4,9
284-B42-3/8	3/8"	158	20,9	20,8	7,4	5,8
284-B42-7/16	7/16"	175	23,4	25,1	8,7	6,2
284-B42-1/2	1/2"	185	24,9	27,15	8,7	6,4
284-B42-9/16	9/16"	193	27,4	29,3	8,7	7
284-B42-5/8	5/8"	213	30,4	33	10,3	7,4
284-B42-11/16	11/16"	231	31,9	35,2	10,3	8,2
284-B42-3/4	3/4"	249	34,5	39,4	10,5	9



8-os. sisältäen koot 5/16-3/8-7/16-1/2-9/16-5/8-11/16-3/4

Tuotekoodi 284-B42-S8T





**Sovitekappaleet räikkälenkkiavaimiin**

Sovitekappaleiden avulla räikkälenkkiavain muuttuu hylsy- tai bitsivääntimeksi. Väänninkoon perässä räikkälenkkiavaimen koko johon se sopii.



Tuotekoodi	Väänninkoko
284-B40-1/4	1/4" x 10 mm
284-B40-3/8	3/8" x 15 mm
284-B40-1/2	1/2" x 19 mm
284-B40-1/4B	1/4" bits x 13 mm



**Yhdistelmäräikkälenkkiavaimet suunnanvaihdolla**

Molemmat lenkipäät porrastettu, jolloin samaan avaimeen on saatu neljä eri avainväliä.

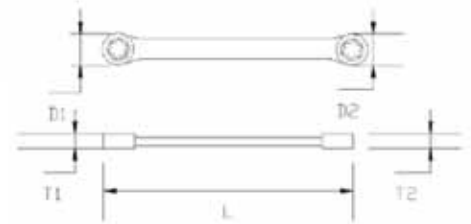
Tuotekoodi	Avainvälit	L	D1	D2	T1	T2
284-B43-8101213	8-10-12-13 mm	165,3	22	24,9	7,9	9
284-B43-9111415	9-11-14-15 mm	180,7	26	30,4	9	10,3
284-B43-12131415	12-13-14-15 mm	181,4	27,4	30,4	9	10,3
284-B43-16171819	16-17-18-19 mm	224,4	31,9	34,4	10,3	11
284-B43-20212224	20-21-22-24 mm	258,4	46,5	46,5	13,5	13,5

**E-Torx räikkälenkkiavaimet**

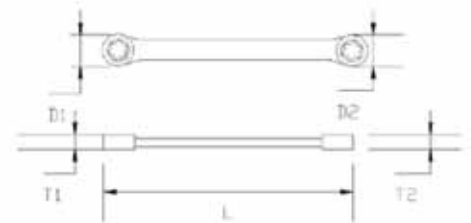
Tuotekoodi	Avainvälit	L	D1	D2	T1	T2
284-B44-E6XE8	E6/E8	130,4	17,4	20,9	7,4	7,4
284-B44-E10XE12	E10/E12	144,4	20,9	22,9	7,4	8,7
284-B44-E14XE18	E14/E18	181,4	27,4	30,4	8,7	10,3
284-B44-E20XE24	E20/E24	224,4	31,9	34,4	10,3	10,3

**Sarja pakattuna säilytyspussiin**

4-os. sisältäen koot E6/E8, E10/E12, E14/E18, E20/E24

Tuotekoodi 284-B44-S4



**Nivelhylsyavaimet**

12-kulmaiset hylsy

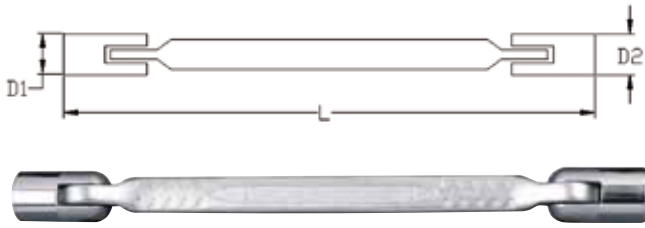

Tuotekoodi	Hylsykoot	L	D1	D2
284-B45-6X7	6/7 mm	176	10,9	10,9
284-B45-8X9	8/9 mm	180	13,8	13,8
284-B45-10X11	10/11 mm	200	14,7	15,9
284-B45-12X13	12/13 mm	220	17,9	18,7
284-B45-14X15	14/15 mm	242	19,6	21,8
284-B45-16X17	16/17 mm	254	23,8	23,8
284-B45-18X19	18/19 mm	275	25,8	25,8



**Jakoavaimet**



Tuotekoodi	L	Aukeama	Paino
284-B994	4"/100 mm	17 mm	50
284-B996	6"/150 mm	24 mm	120
284-B998	8"/200 mm	29 mm	230
284-B9910	10"/250 mm	33 mm	400
284-B9912	12"/300 mm	38 mm	660
284-B9915	15"/375 mm	50 mm	1190
284-B9918	18"/450 mm	60 mm	1870
284-B9924	24"/600 mm	70 mm	3333



**Erikoissuurella aukeamalla:**

Tuotekoodi	L	Aukeama	Paino
284-B996SW	6"/150 mm	34 mm	168
284-B998SW	8"/200 mm	38 mm	300
284-B9910SW	10"/250 mm	50 mm	546





## **Hylsyavaimet, tarvikkeet ja vääntimet**





## 1/4"

### 6-kulmaiset lyhyet hylsyavaimet

Tuotekoodi	Avainväli	D1	D2	L	T
284-B20-4	4 mm	11,8	6,8	25	3,6
284-B20-4,5	4,5 mm	11,8	7,4	25	3,6
284-B20-5	5 mm	11,8	8	25	4,2
284-B20-5,5	5,5 mm	11,8	8,7	25	4,2
284-B20-6	6 mm	11,8	9,3	25	4,8
284-B20-7	7 mm	11,8	10,8	25	5,4
284-B20-8	8 mm	11,8	11,8	25	5,4

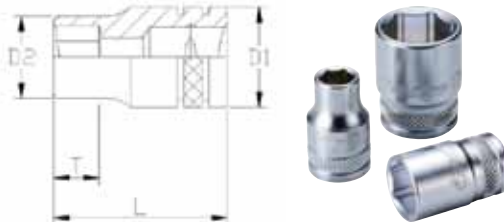

Tuotekoodi	Avainväli	D1	D2	L	T
284-B20-9	9 mm	12,8	12,8	25	6
284-B20-10	10 mm	13,8	13,8	25	7
284-B20-11	11 mm	15,8	15,8	25	8
284-B20-12	12 mm	16,8	16,8	25	8
284-B20-13	13 mm	17,9	17,8	25	8
284-B20-14	14 mm	19,8	19,8	25	10



### 6-kulmaiset lyhyet hylsyavaimet tuumamittaiset

Tuotekoodi	Avainväli	D1	D2	L	T
284-B20-5/32	5/32"	11,8	6,8	25	3,6
284-B20-3/16	3/16"	11,8	8	25	4,2
284-B20-7/32	7/32"	11,8	8,7	25	4,2
284-B20-1/4	1/4"	11,8	9,3	25	4,8
284-B20-9/32	9/32"	11,8	10,8	25	5,4
284-B20-5/16	5/16"	11,8	11,8	25	5,4



Tuotekoodi	Avainväli	D1	D2	L	T
284-B20-11/32	11/32"	12,8	12,8	25	6
284-B20-3/8	3/8"	13,8	13,8	25	7
284-B20-7/16	7/16"	15,8	15,8	25	8
284-B20-15/32	15/32"	16,8	16,8	25	8
284-B20-1/2	1/2"	17,8	17,8	25	8
284-B20-9/16	9/16"	19,8	19,8	25	10



### 6-kulmaiset pitkät hylsyavaimet

Tuotekoodi	Avainväli	D1	D2	L	T
284-B20L-5	5 mm	11,8	8	50	5,5
284-B20L-6	6 mm	11,8	9,3	50	6
284-B20L-7	7 mm	11,8	10,8	50	10,5
284-B20L-8	8 mm	11,8	11,8	50	10,5
284-B20L-9	9 mm	12,8	12,8	50	11,5

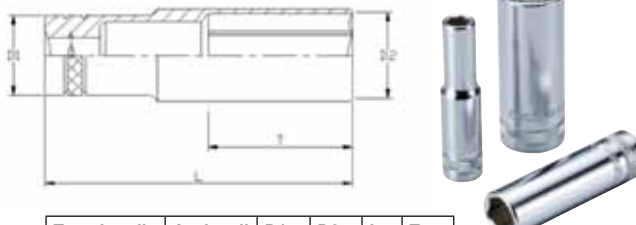

Tuotekoodi	Avainväli	D1	D2	L	T
284-B20L-10	10 mm	13,8	13,8	50	13
284-B20L-11	11 mm	15,8	15,8	50	14
284-B20L-12	12 mm	16,8	16,8	50	15
284-B20L-13	13 mm	17,9	17,8	50	17
284-B20L-14	14 mm	19,8	19,8	50	19



### 6-kulmaiset pitkät hylsyavaimet tuumamittaiset

Tuotekoodi	Avainväli	D1	D2	L	T
284-B20L-3/16	3/16"	11,8	8	50	5,5
284-B20L-7/32	7/32"	11,8	8,7	50	5,5
284-B20L-1/4	1/4"	11,8	9,3	50	6
284-B20L-9/32	9/32"	11,8	10,8	50	10,5
284-B20L-5/16	5/16"	11,8	11,8	50	10,5



Tuotekoodi	Avainväli	D1	D2	L	T
284-B20L-11/32	11/32"	12,8	12,8	50	11,5
284-B20L-3/8	3/8"	13,8	13,8	50	13
284-B20L-7/16	7/16"	15,8	15,8	50	14
284-B20L-1/2	1/2"	17,8	17,8	50	17
284-B20L-9/16	9/16"	19,8	19,8	50	19



**1/4"**

## Hylsyrunkoiset lyhyet kuusiokoloavaimet



Tuotekoodi	Avainväli	D	L
284-B20-IN3	3 mm	11,9	37
284-B20-IN4	4 mm	11,9	37
284-B20-IN5	5 mm	11,9	37
284-B20-IN6	6 mm	11,9	37
284-B20-IN7	7 mm	11,9	37
284-B20-IN8	8 mm	11,9	37

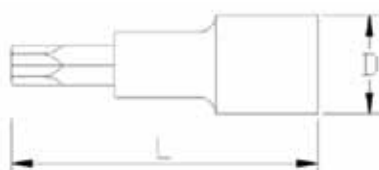
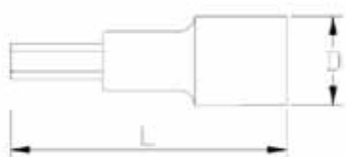

## Hylsyrunkoiset lyhyet Torx®-avaimet

Tuotekoodi	Avainväli	D	L
284-B20-INXT8	T8	11,9	37
284-B20-INXT10	T10	11,9	37
284-B20-INXT15	T15	11,9	37
284-B20-INXT20	T20	11,9	37
284-B20-INXT25	T25	11,9	37
284-B20-INXT27	T27	11,9	37
284-B20-INXT30	T30	11,9	37
284-B20-INXT40	T40	11,9	37



## Hylsyrunkoiset lyhyet kuusiokoloavaimet tuumamittaiset

Tuotekoodi	Avainväli	D	L
284-B20-IN1/8	1/8"	11,9	37
284-B20-IN5/32	5/32"	11,9	37
284-B20-IN3/16	3/16"	11,9	37
284-B20-IN7/32	7/32"	11,9	37

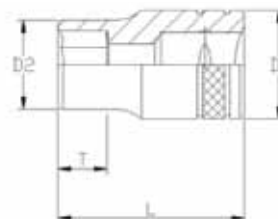

## Hylsyt sisäpuolisella Torx®-vääntiöllä

Tuotekoodi	Avainväli	D1	D2	L	T
284-B20-E4	E4	11,8	6,1	25	4,2
284-B20-E5	E5	11,8	6,9	25	4,2
284-B20-E6	E6	11,8	8	25	4,2
284-B20-E7	E7	11,8	8,8	25	4,2
284-B20-E8	E8	11,8	10	25	4,8
284-B20-E10	E10	13,7	12	25	5,4
284-B20-E11	E11	13,7	12,7	25	6



## Hylsyrunkoiset ruuvauskärjet

Tuotekoodi	Avainväli	D	L
284-B20-PH0	PH0	11,9	37
284-B20-PH1	PH1	11,9	37
284-B20-PH2	PH2	11,9	37
284-B20-PH3	PH3	11,9	37
284-B20-PZ0	PZ0	11,9	37
284-B20-PZ1	PZ1	11,9	37
284-B20-PZ2	PZ2	11,9	37
284-B20-PZ3	PZ3	11,9	37
284-B20-U4	4 mm	11,9	37
284-B20-U4,5	4,5 mm	11,9	37
284-B20-U5,5	5,5 mm	11,9	37
284-B20-U6	6 mm	11,9	37



**1/4"**

**Muuntokappaleet**

1/4"->3/8"

Tuotekoodi 284-B2030

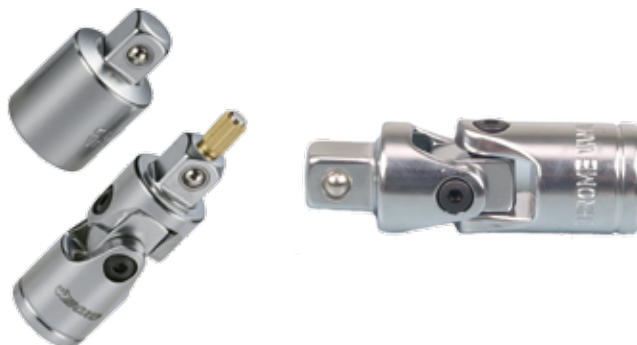

**Nivel**

Tuotekoodi 284-B2095



**Nivel magneetilla**

Tuotekoodi 284-B2095M



**Jatkovarret**

50 mm Tuotekoodi 284-B2090-2

75 mm Tuotekoodi 284-B2090-3

100 mm Tuotekoodi 284-B2090-4

150 mm Tuotekoodi 284-B2090-6



**Jatkovarret 15° kulmapäällä**

50 mm Tuotekoodi 284-B2090-2-15

75 mm Tuotekoodi 284-B2090-3-15

100 mm Tuotekoodi 284-B2090-4-15

150 mm Tuotekoodi 284-B2090-6-15

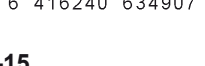

**Jatkovarret magneettipäällä**

50 mm Tuotekoodi 284-B2090M-2

75 mm Tuotekoodi 284-B2090M-3

100 mm Tuotekoodi 284-B2090M-4

150 mm Tuotekoodi 284-B2090M-6

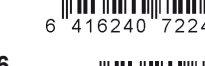

**Joustava jatkovarsi**

150 mm Tuotekoodi 284-B2090J-6



**72-hampainen räikkäväännin**

Suunnanvaihto vivulla. Pituus 147 mm.

Tuotekoodi 284-B2093



**72-hampainen räikkäväännin**

Suunnanvaihto levyllä. Pituus 145 mm.

Tuotekoodi 284-B2093T



**48-hampainen nivelöity räikkäväännin**

Suunnanvaihto vivulla. Pituus 160 mm.

Tuotekoodi 284-B2093N



**Nivelväännin**

Pituus 150 mm.

Tuotekoodi 284-B2096-150



**Ruuvitaltaväännin**

Pituus 150 mm.

Tuotekoodi 284-B2098



**T-väännin**

Pituus 115 mm.

Tuotekoodi 284-B2087





## 6-kulmaiset lyhyet hylsyavaimet

Tuotekoodi	Avainväli	D1	D2	L	T
284-B30-6	6 mm	16,8	10	28	6
284-B30-7	7 mm	16,8	10,8	28	6
284-B30-8	8 mm	16,8	12	28	6
284-B30-9	9 mm	16,8	13,1	28	8
284-B30-10	10 mm	16,8	14,7	28	8
284-B30-11	11 mm	16,8	15,7	28	8
284-B30-12	12 mm	15,7	16,8	28	8
284-B30-13	13 mm	16,5	17,8	28	8
284-B30-14	14 mm	17,5	19,8	28	11
284-B30-15	15 mm	19	21,8	28	11
284-B30-16	16 mm	19,5	21,8	28	12
284-B30-17	17 mm	21,5	23,8	30	12
284-B30-18	18 mm	23	25,8	30	12
284-B30-19	19 mm	23,5	25,8	30	14
284-B30-20	20 mm	25,5	27,8	30	14
284-B30-21	21 mm	26,5	27,8	30	14



284-B30-22	22 mm	28,5	29,8	30	14
284-B30-24	24 mm	29	31,8	30	14

## 6-kulmaiset lyhyet hylsyavaimet tuumamittaiset

Tuotekoodi	Avainväli	D1	D2	L	T
284-B30-1/4	1/4"	16,8	10	28	6
284-B30-5/16	5/16"	16,8	12	28	6
284-B30-3/8	3/8"	16,8	14,7	28	8
284-B30-7/16	7/16"	16,8	15,7	28	8
284-B30-15/32	15/32"	15,7	16,8	28	8
284-B30-1/2	1/2"	16,5	17,8	28	8
284-B30-9/16	9/16"	17,5	19,8	28	11
284-B30-5/8	5/8"	19,5	21,8	28	12
284-B30-11/16	11/16"	21,5	23,8	30	12
284-B30-3/4	3/4"	23,5	25,8	30	14
284-B30-13/16	13/16"	26,5	27,8	30	14
284-B30-7/8	7/8"	28,5	29,8	30	14
284-B30-15/16	15/16"	29	31,8	30	14



**3/8"**



## 6-kulmaiset pitkät hylsyavaimet

Tuotekoodi	Avainväli	D1	D2	L	T
284-B30L-8	8 mm	16,8	12	63	15
284-B30L-9	9 mm	16,8	13,1	63	15
284-B30L-10	10 mm	16,8	14,7	63	19
284-B30L-11	11 mm	16,8	15,7	63	23
284-B30L-12	12 mm	15,7	16,8	63	23
284-B30L-13	13 mm	16,5	18,8	63	23
284-B30L-14	14 mm	17,5	19,8	63	23
284-B30L-15	15 mm	19	21,8	63	23
284-B30L-16	16 mm	19,5	21,8	63	23
284-B30L-17	17 mm	21,5	23,8	63	23
284-B30L-18	18 mm	23	25,8	63	23
284-B30L-19	19 mm	23,5	25,8	63	23
284-B30L-20	20 mm	25	27,8	63	23
284-B30L-21	21 mm	25,5	27,8	63	23
284-B30L-22	22 mm	26,5	29,8	63	23



284-B30L-24	24 mm	29	31,8	63	23
-------------	-------	----	------	----	----

## 6-kulmaiset pitkät hylsyavaimet tuumamittaiset

Tuotekoodi	Avainväli	D1	D2	L	T
284-B30-1/4	1/4"	16,8	10	63	23
284-B30-5/16	5/16"	16,8	12	63	23
284-B30-3/8	3/8"	16,8	14,7	63	23
284-B30-7/16	7/16"	16,8	15,7	63	23
284-B30-1/2	1/2"	16,5	17,8	63	23
284-B30-9/16	9/16"	17,5	19,8	63	23
284-B30-5/8	5/8"	19,5	21,8	63	23
284-B30-11/16	11/16"	21,5	23,8	63	23
284-B30-3/4	3/4"	23,5	25,8	63	23
284-B30-13/16	13/16"	26,5	27,8	63	23
284-B30-7/8	7/8"	28,5	29,8	63	23
284-B30-15/16	15/16"	29	31,8	63	14



3/8"

**Hylsyrunkoiset lyhyet kuusiokoloavaimet**

Tuotekoodi	Avainväli	D	L
284-B30-IN3	3 mm	17,9	48
284-B30-IN4	4 mm	17,9	48
284-B30-IN5	5 mm	17,9	48
284-B30-IN6	6 mm	17,9	48
284-B30-IN7	7 mm	17,9	48
284-B30-IN8	8 mm	17,9	48
284-B30-IN10	10 mm	17,9	48
284-B30-IN12	12 mm	17,9	48
284-B30-IN14	14 mm	17,9	48
284-B30-IN17	17 mm	17,9	48



**Hylsyrunkoiset lyhyet kuusiokoloavaimet tuumamittaiset**

Tuotekoodi	Avainväli	D	L
284-B30-IN5/32	5/32"	17,9	48
284-B30-IN3/16	3/16"	17,9	48
284-B30-IN1/4	1/4"	17,9	48
284-B30-IN5/16	5/16"	17,9	48

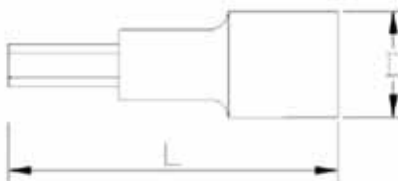

**Hylsyrunkoiset lyhyet Torx®-avaimet**

Tuotekoodi	Avainväli	D	L
284-B30-INXT15	T15	17,9	48
284-B30-INXT20	T20	17,9	48
284-B30-INXT25	T25	17,9	48
284-B30-INXT27	T27	17,9	48
284-B30-INXT30	T30	17,9	48
284-B30-INXT40	T40	17,9	48
284-B30-INXT45	T45	17,9	48
284-B30-INXT50	T50	17,9	48
284-B30-INXT55	T55	17,9	48

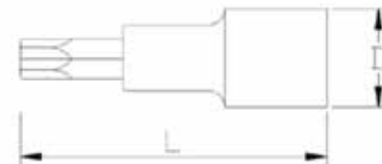

**Hylsy sisäpuolisella Torx®-vääntiöllä**

Tuotekoodi	Avainväli	D1	D2	L	T
284-B30-E5	E5	16,8	7	28	6
284-B30-E6	E6	16,8	8	28	6
284-B30-E7	E7	16,8	9	28	8
284-B30-E8	E8	16,8	10,5	28	8
284-B30-E10	E10	16,8	12	28	8
284-B30-E11	E11	16,8	13	28	8
284-B30-E12	E12	16,8	14	28	8
284-B30-E14	E14	17,8	16	28	11
284-B30-E16	E16	19,8	18	28	11
284-B30-E18	E18	21,8	20	28	12
284-B30-E20	E20	23,8	22	28	12

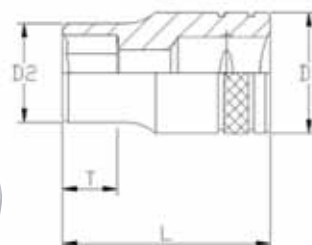

**3/8"**

## Hylsytarvikkeet ja vääntimet

### Muuntokappaleet

3/8"->1/4"

Tuotekoodi 284-B3020



3/8"->1/2"

Tuotekoodi 284-B3019



### Nivel

Tuotekoodi 284-B3095



### Nivel magneetilla

Tuotekoodi 284-B3095M



### Jatkovarret

75 mm Tuotekoodi 284-B3090-3



150 mm Tuotekoodi 284-B3090-6



250 mm Tuotekoodi 284-B3090-10



### Jatkovarret 15° kulmapäällä

75 mm Tuotekoodi 284-B3090-3-15



150 mm Tuotekoodi 284-B3090-6-15



200 mm Tuotekoodi 284-B3090-8-15



### Jatkovarret magneettipäällä

75 mm Tuotekoodi 284-B3090M-3



150 mm Tuotekoodi 284-B3090M-6



250 mm Tuotekoodi 284-B3090M-10



### 72-hampainen räikkäväännin

Suunnanvaihto vivulla.

Pituus 202 mm.

Tuotekoodi 284-B3093



### 72-hampainen räikkäväännin

Suunnanvaihto levyllä.

Pituus 185 mm.

Tuotekoodi 284-B3093T



### 48-hampainen nivelöity räikkäväännin

Suunnanvaihto vivulla.

Pituus 242 mm.

Tuotekoodi 284-B3093N



### Nivelväännin

Pituus 250 mm.

Tuotekoodi 284-B3096-250



### T-väännin

Pituus 165 mm.

Tuotekoodi 284-B3087





## 1/2"

### 6-kulmaiset lyhyet hylsyavaimet

Tuotekoodi	Avainväli	D1	D2	L	T
284-B19-8	8 mm	21,8	13,2	38	9
284-B19-9	9 mm	21,8	13,9	38	10
284-B19-10	10 mm	21,8	15	38	10
284-B19-11	11 mm	21,8	16,3	38	10
284-B19-12	12 mm	21,8	17,6	38	10
284-B19-13	13 mm	21,8	18,8	38	10
284-B19-14	14 mm	21,8	20,4	38	10
284-B19-15	15 mm	21,8	21	38	14
284-B19-16	16 mm	23,3	22	38	14
284-B19-17	17 mm	22	23,8	38	14
284-B19-18	18 mm	23	25,8	38	14
284-B19-19	19 mm	23,5	25,8	38	18
284-B19-20	20 mm	24	27,8	38	18
284-B19-21	21 mm	25	27,8	38	18
284-B19-22	22 mm	26	29,8	38	18
284-B19-23	23 mm	27	31,8	40	18
284-B19-24	24 mm	28	31,8	40	18
284-B19-25	25 mm	30	33,8	40	20
284-B19-26	26 mm	30	33,8	42	20
284-B19-27	27 mm	30	35,8	42	20
284-B19-28	28 mm	32	37,8	44	20

284-B19-29	29 mm	32	37,8	44	20
284-B19-30	30 mm	34	39,8	44	22
284-B19-32	32 mm	36	41,8	44	22



### 6-kulmaiset lyhyet hylsyavaimet tuumamittaiset

Tuotekoodi	Avainväli	D1	D2	L	T
284-B19-5/16	5/16"	21,8	13,2	38	9
284-B19-3/8	3/8"	21,8	15	38	10
284-B19-7/16	7/16"	21,8	16,3	38	10
284-B19-15/32	15/32"	21,8	17,6	38	10
284-B19-1/2	1/2"	21,8	18,8	38	10
284-B19-9/16	9/16"	21,8	20,4	38	10
284-B19-5/8	5/8"	23,3	22	38	14
284-B19-11/16	11/16"	22	23,8	38	14
284-B19-3/4	3/4"	23,5	25,8	38	18
284-B19-13/16	13/16"	25	27,8	38	18
284-B19-7/8	7/8"	26	29,8	38	18
284-B19-15/16	15/16"	28	31,8	40	18
284-B19-1	1"	30	33,8	40	20
284-B19-1 1/16	1 1/16"	30	35,8	42	20
284-B19-1 3/16	1 3/16"	32	37,8	44	20
284-B19-1 1/4	1 1/4"	34	39,8	44	22

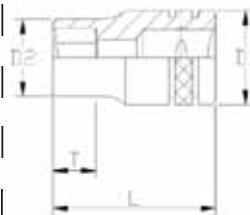

### 6-kulmaiset pitkät hylsyavaimet

Tuotekoodi	Avainväli	D1	D2	L	T
284-B19L-10	10 mm	21,8	15	77	12
284-B19L-11	11 mm	21,8	16,3	77	12
284-B19L-12	12 mm	21,8	17,6	77	12
284-B19L-13	13 mm	21,8	18,8	77	12
284-B19L-14	14 mm	21,8	20,4	77	15
284-B19L-15	15 mm	21,8	21	77	15
284-B19L-16	16 mm	23,3	22	77	15
284-B19L-17	17 mm	22	23,8	77	15
284-B19L-18	18 mm	23	25,8	77	18

284-B19L-19	19 mm	23,5	25,8	77	18
284-B19L-20	20 mm	24	27,8	77	18
284-B19L-21	21 mm	25	27,8	77	18
284-B19L-22	22 mm	26	29,8	77	21
284-B19L-24	24 mm	28	31,8	77	24
284-B19L-27	27 mm	30	35,8	77	27
284-B19L-30	30 mm	34	39,8	77	30
284-B19L-32	32 mm	36	41,8	77	32



1/2"

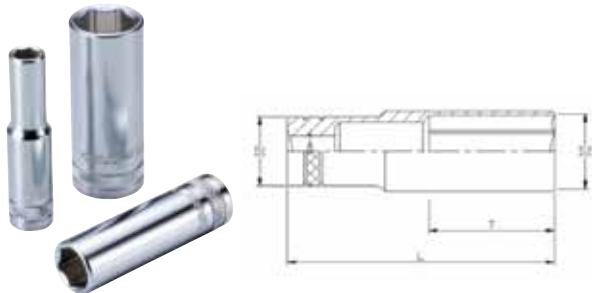

### 6-kulmaiset pitkät hylsyavaimet tuumamittaiset

Tuotekoodi	Avainväli	D1	D2	L	T
284-B19-5/16	5/16"	21,8	13,2	77	12
284-B19-3/8	3/8"	21,8	15	77	12
284-B19-7/16	7/16"	21,8	16,3	77	12
284-B19-1/2	1/2"	21,8	18,8	77	12
284-B19-9/16	9/16"	21,8	20,4	77	15
284-B19-5/8	5/8"	23,3	22	77	15
284-B19-11/16	11/16"	22	23,8	77	15
284-B19-3/4	3/4"	23,5	25,8	77	18
284-B19-13/16	13/16"	25	27,8	77	18
284-B19-7/8	7/8"	26	29,8	77	21
284-B19-15/16	15/16"	28	31,8	77	24
284-B19-1	1"	30	33,8	77	24



### Hylsy sisäpuolisella Torx®-vääntiöllä

Tuotekoodi	Avainväli	D1	D2	L	T
284-B19-E10	E10	21,8	13,2	38	9
284-B19-E11	E11	21,8	13,7	38	9,5
284-B19-E12	E12	21,8	15	38	10
284-B19-E14	E14	21,8	16,5	38	10,5
284-B19-E16	E16	21,8	18,7	38	12
284-B19-E18	E18	21,8	20,5	38	13
284-B19-E20	E20	22	23,8	38	14
284-B19-E22	E22	23	25,8	38	15
284-B19-E24	E24	25	27,8	38	16,3

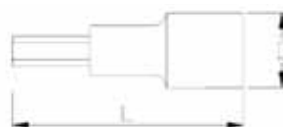

### Hylsyrunkoiset lyhyet kuusiokoloavaimet

Tuotekoodi	Avainväli	D	L
284-B19-IN4	4 mm	23,9	55
284-B19-IN5	5 mm	23,9	55
284-B19-IN6	6 mm	23,9	55
284-B19-IN7	7 mm	23,9	55
284-B19-IN8	8 mm	23,9	55
284-B19-IN10	10 mm	23,9	55
284-B19-IN12	12 mm	23,9	55
284-B19-IN14	14 mm	23,9	55
284-B19-IN17	17 mm	23,9	55
284-B19-IN19	19 mm	23,9	55



### Hylsyrunkoiset lyhyet kuusiokoloavaimet tuumamittaiset

Tuotekoodi	Avainväli	D	L
284-B19-IN1/4	1/4"	23,9	55
284-B19-IN5/16	5/16"	23,9	55
284-B19-IN3/8	3/8"	23,9	55
284-B19-IN1/2	1/2"	23,9	55
284-B19-IN9/16	9/16"	23,9	55
284-B19-IN5/8	5/8"	23,9	55
284-B19-IN3/4	3/4"	23,9	55



### Hylsyrunkoiset pitkät kuusiokoloavaimet

Tuotekoodi	Avainväli	D	L
284-B19L-IN5	5 mm	23,9	1385
284-B19L-IN6	6 mm	23,9	100
284-B19L-IN7	7 mm	23,9	100
284-B19L-IN8	8 mm	23,9	100
284-B19L-IN10	10 mm	23,9	100
284-B19L-IN12	12 mm	23,9	138

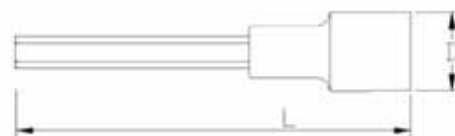

1/2"

**Hylsyrunkoiset lyhyet Torx®-avaimet**

Tuotekoodi	Avainväli	D	L
284-B19-INXT10	T10	23,9	55
284-B19-INXT15	T15	23,9	55
284-B19-INXT20	T20	23,9	55
284-B19-INXT25	T25	23,9	55
284-B19-INXT27	T27	23,9	55
284-B19-INXT30	T30	23,9	55
284-B19-INXT40	T40	23,9	55
284-B19-INXT45	T45	23,9	55
284-B19-INXT50	T50	23,9	55
284-B19-INXT55	T55	23,9	55
284-B19-INXT60	T60	23,9	55
284-B19-INXT70	T70	23,9	55

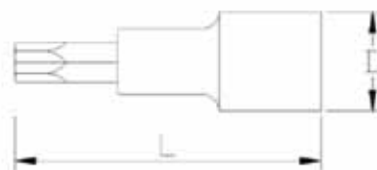

**Hylsyrunkoiset pitkät Torx®-avaimet**

Tuotekoodi	Avainväli	D	L
284-B19L-INXT40	T40	23,9	138
284-B19L-INXT45	T45	23,9	100
284-B19L-INXT55	T55	23,9	138
284-B19L-INXT70	T70	23,9	100

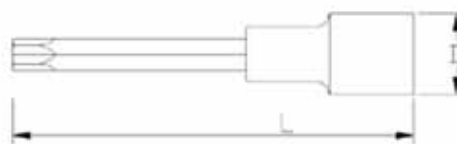

**Hylsyrunkoiset lyhyet XZN-avaimet**

Tuotekoodi	Avainväli	D	L
284-B19-XZN6	M6	23,9	55
284-B19-XZN8	M8	23,9	55
284-B19-XZN10	M10	23,9	55
284-B19-XZN12	M12	23,9	55

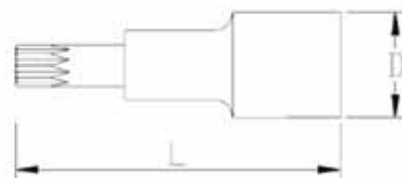

**Hylsyrunkoiset pitkät XZN-avaimet**

Tuotekoodi	Avainväli	D	L
284-B19L-XZN6	M6	23,9	100
284-B19L-XZN8	M8	23,9	100
284-B19L-XZN10	M10	23,9	100
284-B19L-XZN12	M12	23,9	100

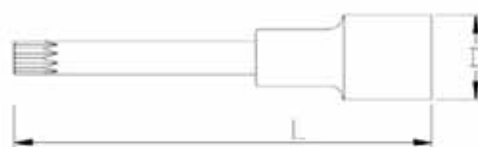



**1/2"**

## Hylsytarvikkeet ja vääntimet

### Muuntokappaleet

1/2"->3/8" Tuotekoodi 284-B1930  6 416240 722208

1/2"->3/4" Tuotekoodi 284-B1932  6 416240 722215



### Nivel

Tuotekoodi 284-B1995  6 416240 634068



### Nivel magneetilla

Tuotekoodi 284-B1995M  6 416240 722314



### Jatkovarret

75 mm Tuotekoodi 284-B1990-3  6 416240 634037

125 mm Tuotekoodi 284-B1990-5  6 416240 634044

250 mm Tuotekoodi 284-B1990-10  6 416240 634020



### Jatkovarret 15° kulmapäällä

75 mm Tuotekoodi 284-B1990-3-15  6 416240 722406

125 mm Tuotekoodi 284-B1990-5-15  6 416240 722413

250 mm Tuotekoodi 284-B1990-10-15  6 416240 722420



### Jatkovarret magneettipäällä

75 mm Tuotekoodi 284-B1990M-3  6 416240 722505

125 mm Tuotekoodi 284-B1990M-5  6 416240 722512

250 mm Tuotekoodi 284-B1990M-10  6 416240 722529



### 72-hampainen räikkäväännin

Suunnanvaihto vivulla. Pituus 265 mm.  
Tuotekoodi 284-B1993  6 416240 722123



### 72-hampainen räikkäväännin

Suunnanvaihto levyllä. Pituus 250 mm.  
Tuotekoodi 284-B1993T  6 416240 634051



### 48-hampainen nivelöity räikkäväännin

Suunnanvaihto vivulla. Pituus 450 mm.  
Tuotekoodi 284-B1993N  6 416240 722154



### Nivelväännin

Pituus 380 mm.  
Tuotekoodi 284-B1996-380  6 416240 722567



### Nivelväännin

Pituus 600 mm.  
Tuotekoodi 284-B1996-600  6 416240 722574

### T-väännin

Pituus 250 mm.  
Tuotekoodi 284-B1987  6 416240 634013



3/4"

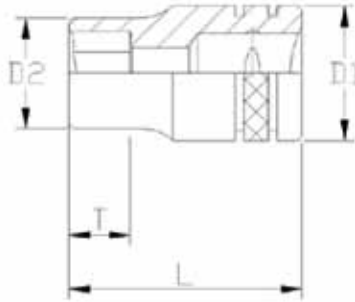

**6-kulmaiset lyhyet hylsyavaimet**

Tuotekoodi	Avainväli	D1	D2	L	T
284-B32-19	19 mm	33	29	50	13
284-B32-21	21 mm	33	31	50	13
284-B32-22	22 mm	36	32	50	14
284-B32-23	23 mm	36	33	50	14
284-B32-24	24 mm	36	34	50	16
284-B32-26	26 mm	36	38	52	17
284-B32-27	27 mm	36	38	52	18
284-B32-28	28 mm	36	40	52	18
284-B32-29	29 mm	38	40	52	18
284-B32-30	30 mm	38	42	54	20

284-B32-32	32 mm	38	44	56	22
284-B32-33	33 mm	38	46	56	22
284-B32-35	35 mm	42	48	58	25
284-B32-36	36 mm	42	50	58	25
284-B32-38	38 mm	45	52	60	25
284-B32-41	41 mm	45	56	64	28
284-B32-46	46 mm	48	62	68	31
284-B32-50	50 mm	48	68	72	34
284-B32-55	55 mm	48	74	76	37
284-B32-60	60 mm	48	80	78	38

**Hylsytarvikkeet ja vääntimet**

**Muuntokappaleet**

3/4" -> 1/2"

Tuotekoodi 284-B3219



**72-hampainen räikkäväännin**

Suunnanvaihto levyllä. Pituus 510 mm.

Tuotekoodi 284-B3293T



**Nivelväännin**

Pituus 600 mm.

Tuotekoodi 284-B3296-600



**T-väännin**

Pituus 460 mm.

Tuotekoodi 284-B3287





## Konehylsyt ja tarvikkeet





3/8"

Kaikkien Boxo-konehylsyjen materiaalina kromimolybdeeni (Cr-Mo)

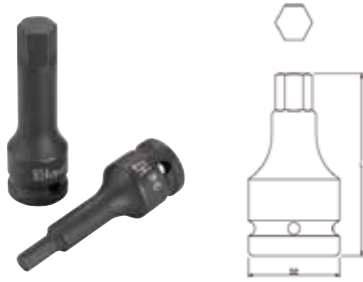

**Konehylsyrunkoiset kuusiokoloavaimet**

Tuotekoodi	Avainväli	D	L
284-B30-KIN4	4 mm	19	60
284-B30-KIN5	5 mm	19	60
284-B30-KIN6	6 mm	19	60
284-B30-KIN8	8 mm	19	60
284-B30-KIN10	10 mm	19	60
284-B30-KIN12	12 mm	19	60
284-B30-KIN14	14 mm	19	60



**Konehylsy sisäpuolisella Torx®-vääntöllä**

Tuotekoodi	Avainväli	D1	D2	L	T
284-B30-KE5	E5	8,2	19	30	4
284-B30-KE6	E6	9,5	19	30	5
284-B30-KE7	E7	10,3	19	30	6
284-B30-KE8	E8	11,4	19	30	6
284-B19-KE10	E10	12,5	19	30	7,5
284-B19-KE11	E11	13,8	19	30	8
284-B19-KE12	E12	15	19	30	8,5
284-B19-KE14	E14	17	19	30	10
284-B19-KE16	E16	19	19	30	11



**Konehylsyrunkoiset Torx®-avaimet**

Tuotekoodi	Avainväli	D	L
284-B30-KINXT20	T20	19	60
284-B30-KINXT25	T25	19	60
284-B30-KINXT27	T27	19	60
284-B30-KINXT30	T30	19	60
284-B30-KINXT40	T40	19	60
284-B30-KINXT45	T45	19	60
284-B30-KINXT50	T50	19	60
284-B30-KINXT55	T55	19	60
284-B30-KINXT60	T60	19	60

**Konehylsyrunkoiset lyhyet Torx®-nivelavaimet**

Tuotekoodi	Avainväli	D	L
284-B30-KINXT20N	T20	24	60
284-B30-KINXT25N	T25	24	60
284-B30-KINXT27N	T27	24	60
284-B30-KINXT30N	T30	24	60
284-B30-KINXT40N	T40	24	60
284-B30-KINXT45N	T45	24	60
284-B30-KINXT50N	T50	24	60
284-B30-KINXT55N	T55	24	60



**Konehylsytarvikkeet**

**Muuntokappaleet**

3/8"->1/2"

Tuotekoodi 284-B3019K



**Nivel**

Tuotekoodi 284-B3095K



**Jatkovarret**

75 mm Tuotekoodi 284-B3090-K3

150 mm Tuotekoodi 284-B3090-K6

250 mm Tuotekoodi 284-B3090-K10



**Kaikkien Boxo-konehylsyjen materiaalina kromimolybdeeni (Cr-Mo)**
**1/2"**

**6-kulmaiset lyhyet konehylsyavaimet**

Tuotekoodi	Avainväli	D1	D2	L	T
284-B19-K8	8 mm	14	25	38	6
284-B19-K9	9 mm	15	25	38	6
284-B19-K10	10 mm	17	25	38	6
284-B19-K11	11 mm	18	25	38	8
284-B19-K12	12 mm	19	25	38	8
284-B19-K13	13 mm	20	25	38	8
284-B19-K14	14 mm	22	25	38	8
284-B19-K15	15 mm	23	30	38	8
284-B19-K16	16 mm	24	30	38	9
284-B19-K17	17 mm	26	30	38	9
284-B19-K18	18 mm	27	30	38	10
284-B19-K19	19 mm	28	30	38	10
284-B19-K21	21 mm	30	30	38	12



284-B19-K22	22 mm	31,8	30	38	12
284-B19-K24	24 mm	33,8	30	38	14
284-B19-K27	27 mm	37,8	30	43	14
284-B19-K30	30 mm	41,8	30	43	16
284-B19-K32	32 mm	43,8	30	43	18

**6-kulmaiset pitkät konehylsyavaimet**

Tuotekoodi	Avainväli	D1	D2	L	T
284-B19L-K17	17 mm	26	30	78	17
284-B19L-K19	19 mm	28	30	78	20
284-B19L-K21	21 mm	30	30	78	22
284-B19L-K22	22 mm	31,8	30	78	22
284-B19L-K24	24 mm	33,8	30	78	24
284-B19L-K27	27 mm	37,8	30	78	27
284-B19L-K30	30 mm	41,8	30	78	30
284-B19L-K32	32 mm	43,8	30	78	32

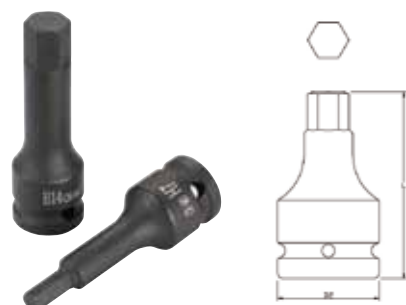
**Konehylsyrunkoiset kuusiokoloavaimet**

Tuotekoodi	Avainväli	D	L
284-B19-KIN4	4 mm	25	78
284-B19-KIN5	5 mm	25	78
284-B19-KIN6	6 mm	25	78
284-B19-KIN8	8 mm	25	78
284-B19-KIN10	10 mm	25	78
284-B19-KIN12	12 mm	25	78
284-B19-KIN14	14 mm	25	78
284-B19-KIN17	17 mm	25	78
284-B19-KIN19	19 mm	25	78

**Konehylsy sisäpuolisella Torx®-vääntiöllä**

Tuotekoodi	Avainväli	D1	D2	L	T
284-B19-KE10	E10	14,2	25	38	7,5
284-B19-KE11	E11	15	25	38	8
284-B19-KE12	E12	16	25	38	8,5
284-B19-KE14	E14	18	25	38	10
284-B19-KE16	E16	20	25	38	11
284-B19-KE18	E18	22	25	38	12
284-B19-KE20	E20	24	30	38	14
284-B19-KE22	E22	25,5	30	45	16
284-B19-KE24	E24	28	30	45	18

1/2"



**Konehylsyrunkoiset Torx®-avaimet**

Tuotekoodi	Avainväli	D	L
284-B19-KINXT20	T20	25	77
284-B19-KINXT25	T25	25	77
284-B19-KINXT27	T27	25	77
284-B19-KINXT30	T30	25	77
284-B19-KINXT40	T40	25	77
284-B19-KINXT45	T45	25	77
284-B19-KINXT50	T50	25	77
284-B19-KINXT55	T55	25	77
284-B19-KINXT60	T60	25	77
284-B19-KINXT70	T70	25	77



**Konehylsyrunkoiset lyhyet Torx®-nivellavaimet**

Tuotekoodi	Avainväli	D	L
284-B19-KINXT30N	T30	28	70
284-B19-KINXT40N	T40	28	70
284-B19-KINXT45N	T45	28	70
284-B19-KINXT50N	T50	28	70
284-B19-KINXT55N	T55	28	70
284-B19-KINXT60N	T60	28	70



**Konehylsytarvikkeet**

**Muuntokappaleet**

1/2"->3/8"

Tuotekoodi 284-B1930K



1/2"->3/4"

Tuotekoodi 284-B1932K



**Nivel**

Tuotekoodi 284-B1995K



**Jatkovarret**

75 mm

Tuotekoodi 284-B1990-K3



125 mm

Tuotekoodi 284-B1990-K5



250 mm

Tuotekoodi 284-B1990-K10



300 mm

Tuotekoodi 284-B1990-K12





**Kaikkien Boxo-konehylsyjen materiaalina kromimolybdeeni (Cr-Mo)**

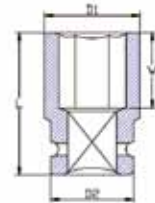
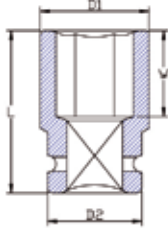

**3/4"**

### 6-kulmaiset lyhyet konehylsyavaimet

Tuotekoodi	Avainväli	D1	D2	L	T
284-B32-K17	17 mm	28,5	38	50	7
284-B32-K18	18 mm	29,5	38	50	7
284-B32-K19	19 mm	30	38	52	9
284-B32-K21	21 mm	32	38	52	11
284-B32-K22	22 mm	34	38	52	14
284-B32-K23	23 mm	35	38	52	14
284-B32-K24	24 mm	36	38	52	14
284-B32-K26	26 mm	38	38	52	14
284-B32-K27	27 mm	40	40	52	14
284-B32-K28	28 mm	42	42	52	15
284-B32-K29	29 mm	42	42	52	15
284-B32-K30	30 mm	44	44	52	15
284-B32-K32	32 mm	46	44	52	15
284-B32-K33	33 mm	48	44	56	18
284-B32-K35	35 mm	50	44	56	18
284-B32-K36	36 mm	52	44	56	18
284-B32-K38	38 mm	53	44	56	18
284-B32-K41	41 mm	58	44	62	22
284-B32-K46	46 mm	67	44	63	24
284-B32-K50	50 mm	71	54	72	30
284-B32-K55	55 mm	77	54	74	30

### 6-kulmaiset pitkät konehylsyavaimet

Tuotekoodi	Avainväli	D1	D2	L	T
284-B32L-K19	19 mm	30	38	90	12
284-B32L-K21	21 mm	32	38	90	12
284-B32L-K22	22 mm	34	38	90	19
284-B32L-K23	23 mm	35	38	90	19
284-B32L-K24	24 mm	36	38	90	19
284-B32L-K26	26 mm	38	38	90	19
284-B32L-K27	27 mm	40	40	90	19
284-B32L-K28	28 mm	42	42	90	19
284-B32L-K29	29 mm	42	42	90	19
284-B32L-K30	30 mm	44	44	90	19
284-B32L-K32	32 mm	46	44	90	19
284-B32L-K33	33 mm	48	44	90	19
284-B32L-K35	35 mm	50	44	90	19
284-B32L-K36	36 mm	52	44	90	19
284-B32L-K38	38 mm	53	44	92	19
284-B32L-K41	41 mm	58	44	92	56
284-B32L-K46	46 mm	67	44	92	56
284-B32L-K50	50 mm	71	54	95	56
284-B32L-K55	55 mm	77	54	100	56

### Konehylsyrunkoiset kuusiokoloavaimet

Tuotekoodi	Avainväli	D	L
284-B32-KIN12	12 mm	44	100
284-B32-KIN14	14 mm	44	100
284-B32-KIN17	17 mm	44	100
284-B32-KIN19	19 mm	44	100
284-B32-KIN22	22mm	44	100



### Konehylsytarvikkeet

#### Muuntokappaleet

3/4"->1/2"

Tuotekoodi 284-B3219K



3/4"->1"

Tuotekoodi 284-B3221K



#### Jatkovarret

100 mm

Tuotekoodi 284-B3290-K4

175 mm

Tuotekoodi 284-B3290-K7

250 mm

Tuotekoodi 284-B3290-K10



1"

Kaikkien Boxo-konehylsyjen materiaalina kromimolybdeeni (Cr-Mo)

**6-kulmaiset lyhyet konehylsyavaimet**



Tuotekoodi	Avainväli	D1	D2	L	T	
284-B21-K24	24 mm	40	51	58	14	6 416240 723984
284-B21-K27	27 mm	44	51	58	14	6 416240 723991
284-B21-K30	30 mm	48	51	60	16	6 416240 724004
284-B21-K32	32 mm	51	52	60	19	6 416240 724011
284-B21-K33	33 mm	53	52	62	19	6 416240 724028
284-B21-K36	36 mm	56	52	62	19	6 416240 724035
284-B21-K41	41 mm	61,5	52	62	23	6 416240 724042
284-B21-K46	46 mm	68	58	64	23	6 416240 724059
284-B21-K50	50 mm	73	58	70	26	6 416240 724066
284-B21-K55	55 mm	79	62	72	28	6 416240 724073
284-B21-K60	60 mm	87	62	78	31	6 416240 724080
284-B21-K65	65 mm	93	62	80	32	6 416240 724097
284-B21-K70	70 mm	98	62	85	35	6 416240 724103



**6-kulmaiset pitkät konehylsyavaimet**

Tuotekoodi	Avainväli	D1	D2	L	T	
284-B21L-K24	24 mm	40,5	51	90	16	6 416240 724110
284-B21L-K27	27 mm	44	51	90	19	6 416240 724127
284-B21L-K32	32 mm	51	51	90	19	6 416240 724134
284-B21L-K33	33 mm	53	52	90	23	6 416240 724141

**Konehylsytarvikkeet**

**Muuntokappaleet**

1"->3/4" Tuotekoodi 284-B2132K 6 416240 724516

**Jatkovarret**

100 mm Tuotekoodi 284-B2190-K4 6 416240 724622

250 mm Tuotekoodi 284-B2190-K10 6 416240 724639



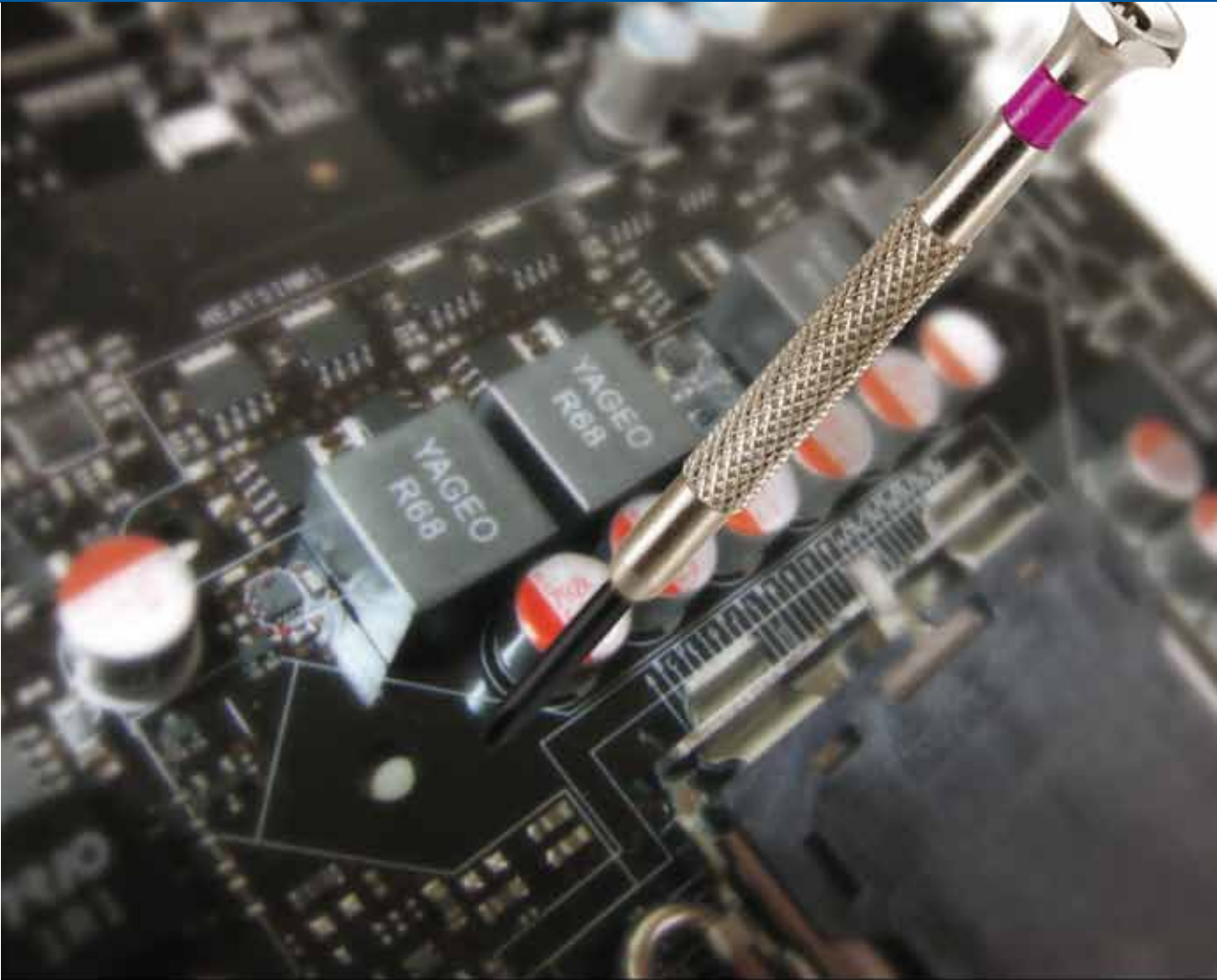

## Ruuvitaltat





**Uraruuvitaltat**

Tuotekoodi	Terä	L	L1	D
284-B60-03075	3,0	145	75	3
284-B60-04100	4,0	194	100	5
284-B60-06100	6,0	210	100	6
284-B60-08150	8,0	270	150	8
284-B60-09200	9,5	320	200	9,5

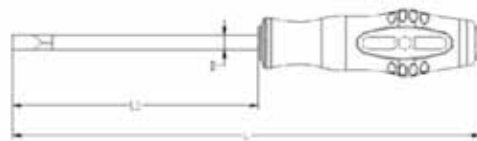
**Ristiuraruuvitaltat Phillips**

Tuotekoodi	Terä	L	L1	D
284-B60-00075	PH0	145	75	6
284-B60-01100	PH1	194	100	5
284-B60-02100	PH2	210	100	6
284-B60-03150	PH3	270	150	8
284-B60-04200	PH4	320	200	9,5

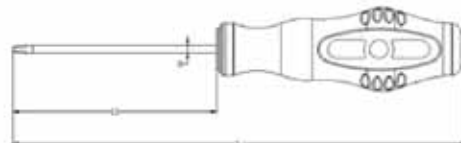
**Ristiuraruuvitaltat Pozidrive**

Tuotekoodi	Terä	L	L1	D
284-B60-00075Z	PZ0	145	75	6
284-B60-01075Z	PZ1	194	100	5
284-B60-02100Z	PZ2	210	100	6
284-B60-03150Z	PZ3	270	150	8

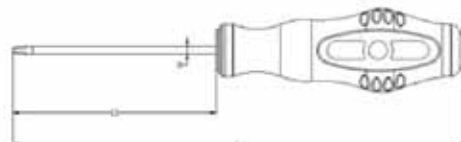
**Erikoislyhyet ruuvitaltat**

Tuotekoodi	Terä	L	L1	D
284-B60-06038	6,0	100	38	6
284-B60-02038	PH2	100	38	6

**Torx-ruuvitaltat**

Tuotekoodi	Terä	L	L1	D
284-B60-08075R	T8	169	75	3
284-B60-10075R	T10	169	75	4
284-B60-15075R	T15	169	75	4
284-B60-20075R	T20	169	75	4
284-B60-25100R	T25	210	100	4
284-B60-27100R	T27	210	100	6
284-B60-30100R	T30	210	100	6
284-B60-40125R	T40	245	125	8

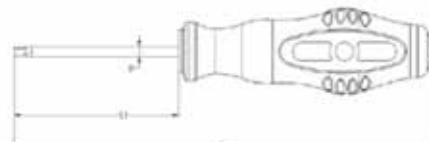
**1/4" Bits-magneettiväännin**

Tuotekoodi	Terä	L	L1	D
284-B60-1/4BM	1/4"	210	101	10



**Lyöntiruuvitaltat**

Lyöntiruuvitaltoissa metallirunko kulkee kahvan läpi päättyen lyöntipäähän kahvan päässä. Tämä ei kuitenkaan tarkoita että itse teräosa kestää jatkuvia iskuja vaan terä on samaa materiaalia kuin tavallisissakin ruuvitaltoissa. Niinpä lyöntiruuvitaltat eivät kuulu normaaliin työkalutakuun piiriin mikäli niitä on lyöty vasaralla tai käytetty vääntörautana.

**Urraruuvitaltat**

Tuotekoodi	Terä	L	L1	D
284-B61-05100	5,0	194	100	3
284-B61-06100	6,0	210	100	6
284-B61-08150	8,0	270	150	8
284-B61-09200	9,5	320	200	9,5

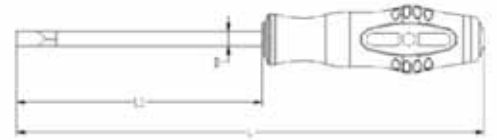
**Ristiuraruuvitaltat Phillips**

Tuotekoodi	Terä	L	L1	D
284-B61-01100	PH1	194	100	5
284-B61-02100	PH2	210	100	6
284-B61-03150	PH3	270	150	8
284-B61-04200	PH4	320	200	9,5

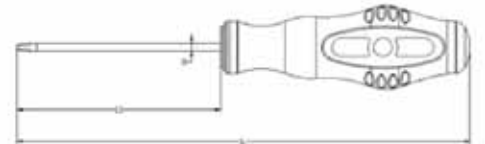
**Erikoislyhyet ruuvitaltat**

Tuotekoodi	Terä	L	L1	D
284-B61-06038	6,0	100	38	6
284-B61-02038	PH2	100	38	6

**Torx-ruuvitaltat**

Tuotekoodi	Terä	L	L1	D
284-B61-20075	T20	162	75	4
284-B61-25100	T25	187	100	4
284-B61-27100	T27	187	100	6
284-B61-30100	T30	210	100	6
284-B61-40125	T40	245	125	8
284-B61-45150	T45	270	150	8
284-B61-50175	T50	295	175	9,5

**Tarkkuusruuvitalttasarjat**
**Kuusiosaiset sarjat sisältäen:**

PH00, PH0, PH1, 1,5, 2,0, 3,0  
**Tuotekoodi 284-B62-1007**



T5, T6, T7, T8, T10, T15  
**Tuotekoodi 284-B62-1007T**



Sarjojen sisältämien ruuvitalttojen terien pituus 50 mm.



**Kuusiokolo- ja torxsarjat**

**Pitkät pallopäiset kuusiokoloavaimet muovipititissä**

Millimitat 9-os. 1,5-2-2,5-3-4-5-6-8-10 mm

Tuotekoodi 284-B91-3467



Tuumamitat 13-os. 1/18-1/16-5/64-3/32-7/64-1/8-9/64-5/32-3/16-7/32-1/4-5/16-3/8

Tuotekoodi 284-B91-3467SAE



**Pitkät Torx-avaimet muovipititissä**

9-os. T10-15-20-25-27-30-40-45-50

Tuotekoodi 284-B91-3467T



**L-kahvaiset kuusiokoloavaimet kaksikomponenttikahvalla**

**Millimitat**

Tuotekoodi	Avainväli	L1	L2
284-B90-2	2	138	64
284-B90-2,5	2,5	138	64
284-B90-3	3	138	64
284-B90-4	4	196	78
284-B90-5	5	196	78
284-B90-6	6	256	98
284-B90-8	8	256	98
284-B90-10	10	256	98



**Tuumamitat**

Tuotekoodi	Avainväli	L1	L2
284-B90-1/8	1/8	138	64
284-B90-9/64	9/64	138	64
284-B90-5/32	5/32	138	64
284-B90-3/16	3/16	196	78
284-B90-7/32	7/32	196	78
284-B90-1/4	1/4	256	98
284-B90-5/16	5/16	256	98
284-B90-3/8	3/8	256	98



**L-kahvaiset torxavaimet kaksikomponenttikahvalla**

Tuotekoodi	Avainväli	L1	L2
284-B90-T10	T10	138	64
284-B90-T15	T15	138	64
284-B90-T20	T20	138	64
284-B90-T25	T25	146	78
284-B90-T27	T27	146	78
284-B90-T30	T30	206	98
284-B90-T40	T40	206	98
284-B90-T45	T45	206	98
284-B90-T50	T50	206	98







## Pihdit



**Linjapihdit**



Tuotekoodi	Pituus	Kahva	Leikkuukapasiteetti Ø mm	
			Rautalanka	Pianolanka
284-B1-10160	160	2K	2,5	2
284-B1-10180	180	2K	3	2,5
284-B1-10200	200	2K	3	2,5



**Kärkipihdit suorat**

Tuotekoodi	Pituus	Kahva	Leikkuukapasiteetti Ø mm	
			Rautalanka	Pianolanka
284-B1-10160	160	2K	2	1,5
284-B1-10200	200	2K	2,2	1,6



**Kärkipihdit taivutetut**

Tuotekoodi	Pituus	Kahva	Leikkuukapasiteetti Ø mm	
			Rautalanka	Pianolanka
284-B1-12160	160	2K	2	1,5
284-B1-12200	200	2K	2,2	1,6



**Sivuleikkurit**

Tuotekoodi	Pituus	Kahva	Leikkuukapasiteetti Ø mm	
			Rautalanka	Pianolanka
284-B1-13160	160	2K	2	1,5



**Voimasivuleikkurit**

Tuotekoodi	Pituus	Kahva	Leikkuukapasiteetti Ø mm	
			Rautalanka	Pianolanka
284-B1-13180V	180	2K	2,5	2
284-B1-13200V	200	2K	4	2,5



**Yleispihdit**

Tuotekoodi	Pituus	Kahva	Leukojen aukeama
284-B1-14250	250	2K	38



**Pitkät kärkipihdit**

Tuotekoodi	Pituus	Kärjet	Kahva
284-B1-4127500	275	Suora	Muovipinnoite
284-B1-4127545	275	45°	Muovipinnoite
284-B1-4127590	275	90°	Muovipinnoite



### Ulkopuoliset lukkorengaspihdit

Tuotekoodi	Kärjet	Pituus	Kahva
284-B1-31125	Suora	125	Muovipinnoite
284-B1-31125T	90°	125	Muovipinnoite
284-B1-31180	Suora	180	Muovipinnoite
284-B1-31180T	90°	180	Muovipinnoite



### Sisäpuoliset lukkorengaspihdit

Tuotekoodi	Kärjet	Pituus	Kahva
284-B1-32125	Suora	125	Muovipinnoite
284-B1-32125T	90°	125	Muovipinnoite
284-B1-32180	Suora	180	Muovipinnoite
284-B1-32180T	90°	180	Muovipinnoite



### Elektroniikkapihdit

Tuotekoodi	Malli	Pituus	Kahva
284-B1-21120	Linjapihdit	120	2K
284-B1-22135	Kärkipihdit	135	2K
284-B1-24125	Kärkipihdit taiv.	125	2K
284-B1-25115	Sivuleikkurit	115	2K



### Automaattikuorintapihdit

0,13 – 8 mm<sup>2</sup> johdoille. Sisältää myös johdonliitinpihdit eristetyille ja eristämättömille liittimille.

**Tuotekoodi 284-B1-401**



### Johdonliitin- ja kuorintapihdit

Eristetyille ja eristämättömille liittimille.

**Tuotekoodi 284-B1-402**



### Johdinsidepihdit

Täysmetallinen pihti kiristää ja katkaisee johdinsiteen yhdellä liikkeellä.

Kireys säädettävissä. Suurin siteen leveys 6,35 mm.

**Tuotekoodi 284-B1-403**



### Johdonliitinpihtisarja

Sarja sisältää pakkopuristepihtiurongon ja kuusi vaihdettavaa leukaparia:

- Eristetyt liittimet 0,5-6,0 mm<sup>2</sup>
- Eristämättömät liittimet 0,5-6,0 mm<sup>2</sup>
- Holkkiliittimet
- Pääteholkkiliittimet 0,5-6,0 mm<sup>2</sup>
- BNC-liittimet RG58, 59

**Tuotekoodi 284-B1-404**







### Kaarevat leuat leikkurilla

Tuotekoodi	Pituus	Aukeama
284-B50-5	125	28
284-B50-7	180	38
284-B50-10	250	47



### Suorat leuat

Tuotekoodi	Pituus	Aukeama
284-B50S-7	180	36
284-B50S-10	250	45



### Pitkät leuat

Tuotekoodi	Pituus	Aukeama
284-B50L-6	150	35
284-B50L-9	225	75



### C-leuat

Tuotekoodi	Pituus	Aukeama
284-B50C-6	150	40
284-B50C-11	275	80



### Levyleuat

Tuotekoodi	Pituus	Aukeama
284-B50L-8	200	65
284-B50L-10	250	76



### Hitsausleuat

Tuotekoodi	Pituus	Aukeama
284-B50H-9	225	65
284-B50H-11	275	76



### Peltisakset

Materiaali kromimolybdeeni, hammastetut leikkuuterät.  
Pituus 250 mm.

Leikkuukapasiteetti:

- Kylmävalssattu teräs 1,2 mm
- Ruostumaton teräs 0,7 mm

Vasemmalle leikkaavat

**Tuotekoodi 284-B1-4250**



Oikealle leikkaavat

**Tuotekoodi 284-B1-4260**



Suoraan leikkaavat

**Tuotekoodi 284-B1-4270**







## **Vasarat, viilat, sahat, huoltotyökalut**





### Harjapävasara

Hikkorivarsi

Tuotekoodi	Paino	Pituus
284-B71-300	300	300
284-B71-500	500	320
284-B71-800	800	350
284-B71-1000	1000	360



### Moska

Hikkorivarsi

Tuotekoodi	Paino	Pituus
284-B72-1100	1100	265
284-B72-1400	1400	265
284-B72-1800	1800	265



### Rekyyliön vasara

Jälkiä jättämätön kestävä kumipinnoite.

Tuotekoodi	Lyöntipää Ø	Paino	Pituus
284-B73-35	35	400	260
284-B73-45	45	520	286
284-B73-55	55	1050	350
284-B73-65	65	1500	370



### Muovi/kumivasara

Teräsputkivarsi

Tuotekoodi	Paino	Pituus
284-B74-16	454	314



### Lieriötuurnat

Materiaali Cr-V, varustettu käsisuojalla.

Tuotekoodi	Koko
284-B70-2	2x140
284-B70-3	3x150
284-B70-4	4x180
284-B70-5	5x200
284-B70-6	6x210
284-B70-8	8x220



### Pistepuikko

Materiaali Cr-V, varustettu käsisuojalla.

Tuotekoodi	Koko
284-B70-PP4	4x185



### Lieriötuurnasarja

6-osainen sarja muovipitimessä – ei käsisuojaa. Sisältää koot 2-3-4-5-6-8 mm.

Tuotekoodi 284-B70-S6



### Rautasaha 300 mm

Kaksikomponenttikahvat, rungossa säilytystila varaterille.  
Terä käännettävissä eri kulmiin.

Tuotekoodi 284-B21006



### Viilat

Pitävä kaksikomponenttikahva.

Tuotekoodi	Muoto
284-BSF-01	Puolipyöreä
284-BSF-02	Litteä
284-BSF-03	Kolmikulmio
284-BSF-04	Pyöreä
284-BSF-05	Nelikulmio







**Sytytustulppahylsyt**

Tuotekoodi	Vääntiö	Avainväli	Pidin	
284-B53	3/8"	16	Kumi	 6 416240 636819
284-B53M	3/8"	16	Magneetti	 6 416240 722253
284-B52	3/8"	21	Kumi	 6 416240 636802
284-B52M	3/8"	21	Magneetti	 6 416240 722260
284-B375	1/2"	16	Kumi	 6 416240 722239
284-B375M	1/2"	16	Magneetti	 6 416240 722277
284-B549	1/2"	21	Kumi	 6 416240 722246
284-B549M	1/2"	21	Magneetti	 6 416240 722284





**Vannehylsyt**

6-kulmaiset pitkät kavennetut vannehylsyavaimet suojahylsillä

Tuotekoodi	Avainväli	L	
284-B19-KLT17	17 mm	85	 6 416240 632958
284-B19-KLT19	19 mm	85	 6 416240 632965
284-B19-KLT21	21 mm	85	 6 416240 632972
284-B19-KLT22	22 mm	85	 6 416240 724646



6-kulmaiset pitkät kavennetut jatkoarrelliset vannehylsyavaimet suojahylsillä

Tuotekoodi	Avainväli	L	
284-B19-KLLT17	17 mm	150	 6 416240 724653
284-B19-KLLT19	19 mm	150	 6 416240 724660
284-B19-KLLT21	21 mm	150	 6 416240 724677





**Vannehlysysarjat**

6-kulmaiset pitkät kavennetut vannehlysyavaimet suojahlysyllä

**Koot:** 17-19-21 mm

**Tuotekoodi 284-B171921**



**Koot:** 17-19-21-22 mm

**Tuotekoodi 284-B17192122**



6-kulmaiset pitkät kavennetut jatkovarrelliset vannehlysyavaimet suojahlysyllä.



**Koot:** 17-19-21 mm

**Tuotekoodi 284-B171921L**









Maahantuoja ja tukkumyyjä:



Malminkaari 12 00700 Helsinki  
Postios. PL 115 00701 Helsinki  
Puh. 010 650 11, fax 010 6501 202  
Sähköposti: koivunen@koivunen.fi  
Internet: www.koivunen.fi



1-800-699-1000